

# TRUCK / CV 20 SPECIAL 26



Das Werkzeug

**HEAVY EDITION!**



We're celebrating  
**10**  
YEARS OF  
TRUCK / CV  
SPECIAL

NKW26/EN/XX/0

**Powerful tools for powerful machines!**

# 10 YEARS OF TRUCK / CV SPECIAL – POWERFUL. PRECISE. UNSTOPPED.

For 10 years, the HAZET commercial vehicle programme has provided powerful solutions in the heavy-duty sector. Developed for the highest loads, made for tough everyday workshop use. To mark our anniversary, we are showing what real tool expertise is all about: compact, precise and 100% practical. Discover the new brochure now!

# 10

YEARS OF  
TRUCK / CV  
SPECIAL



## EFFICIENT USE OF DRAWERS DOWN TO THE SMALLEST DETAIL

With the new HAZET drawer configurator tool, tool trolleys can now be equipped individually and precisely. The online tool helps users to optimally arrange HAZET soft foam inserts in drawers - conveniently with a click or with the intuitive drag and drop function.

Regardless of whether it is a current HAZET tool trolley Assistent® or a freely defined drawer size: the configurator automatically recognises the remaining space and only displays suitable inserts for selection. It is also easy to search for inserts with special features - such as pliers, screwdrivers or sockets.

### This is how it works:

- ▶ Select the model or enter the drawer dimensions
- ▶ Position suitable inserts from the extensive assortment
- ▶ Save configuration and export it as PDF or Excel file
- ▶ In addition, the configurations can easily be sent to specialist dealers, and the desired inserts can be ordered directly

**A special bonus: the saved compilation can be accessed and adjusted at any time via a link.**



To the  
HAZET drawer  
configurator



*Assistent®*

Tool trolley production

**Made in Germany**



- ▶ State-of-the-art control and digital monitoring of the production process
- ▶ Scanner for automatic component recognition

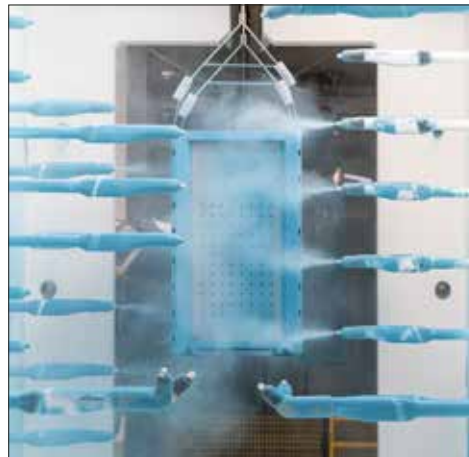

- ▶ Up to 29 high-performance powder guns
- ▶ Shuttles every 2.5 minutes

## BUILT FOR THE FUTURE - PERFECTLY COATED!

Our new powder coating plant sends a strong signal about our Remscheid location and our corporate philosophy, which is based on state-of-the-art, professional production **Made in Germany**. It complements our fully automatic laser/punching and bending centres as well as our welding robots.

As one of the most modern facilities in Europe, the powder coating plant ensures that our Assistent® brand tool trolleys and work benches receive their characteristic, long-lasting protective coating. At the same time, the use of materials and energy is more sustainable.

### Individual colours:

- You can choose an individual colour from a production run of just one tool trolley (applies to the colour of the trolley body).
- Other colours on request

Printed colours may differ from the original RAL colour tone

24 RAL colours can be implemented at short notice. Other colours on request.

RAL1021		RAL5012		RAL7016	
RAL2002		RAL5013		RAL7021	
RAL3000		RAL5015		RAL7035	
RAL3002		RAL6005		RAL8022	
RAL3020		RAL6018		RAL9003	
RAL5005		RAL7004		RAL9005	
RAL5010		RAL7012		RAL9006	
RAL5011		RAL7015		RAL9016	

Available from 1 piece,  
surcharge for colour



## TOOL TROLLEYS AND WORK BENCHES

- ▶ 179N series – Suitable for every application: with a narrow width of 785 mm up to XXL format with a width of 1,133 mm and a depth of up to 642 mm
- ▶ Extremely robust design thanks to double-walled construction
- ▶ Secure locking and heavy-duty drawer concept
- ▶ Sealed working surfaces protect trolley interior
- ▶ Side cylinder lock (replaceable)
- ▶ Two folding keys (can be reordered, including serial number)
- ▶ "Non-marking" castors leave no marks on the floor
- ▶ Developed and produced by HAZET "Made in Germany"

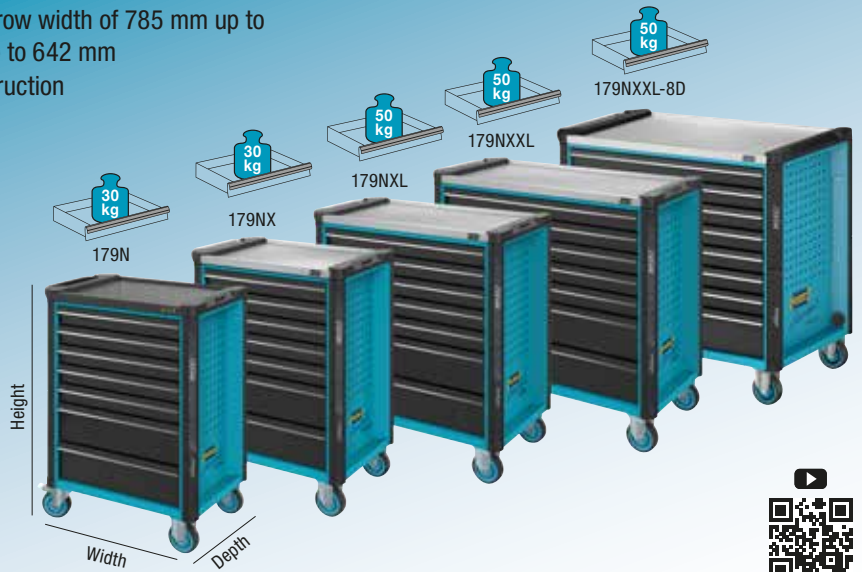

Assistant®

**Made in Germany**



### 179N

- Plastic work surface

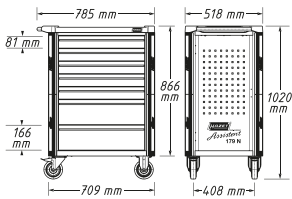

**Made in Germany**

HAZET No.	Number of drawers	EAN-No. 4000896 +
179N-6	6	214570
179N-7	7	214488
179N-8	8	214587
179N-9	9	220236

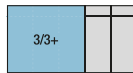

### 179NX

- Stainless steel work surface

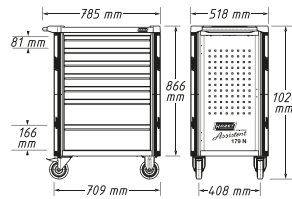

**Made in Germany**

HAZET No.	Number of drawers	EAN-No. 4000896 +
179NX-6	6	215560
179NX-7	7	215577
179NX-8	8	215584

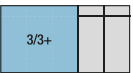

### 179NXL

- Stainless steel work surface

**Wide design**

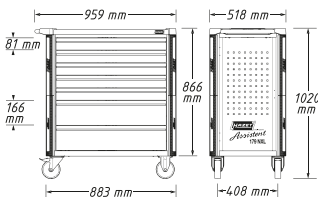

**Made in Germany**

HAZET No.	Number of drawers	EAN-No. 4000896 +
179NXL-6	6	215171
179NXL-7	7	215164
179NXL-8	8	215218



### 179NXXL

- Stainless steel work surface

**Extra wide design**

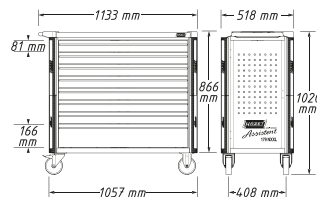

**Made in Germany**

HAZET No.	Number of drawers	EAN-No. 4000896 +
179NXXL-7	7	214624
179NXXL-8	8	214778

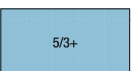

# Powerful. Robust. Made for tough applications!

## 179NWL

- Mobile work bench

Continuous drawer width!

100% sliding-out with ball-bearing telescopic rails – self-closing!

2 swivel castors with dual brake!

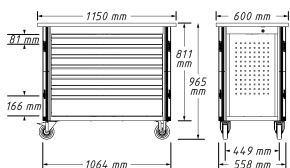

30 mm wood multiplex birch work surface, oiled on both sides, replaceable

**NEW!**

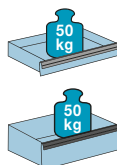

Laterally replaceable cylinder lock with 2 folding keys (incl. serial number)

Made in Germany

HAZET No.	Equipment	EAN-No. 4000896 +
179NWL-7	6 flat drawers, 1 high drawer	280544
179NWL-8	8 flat drawers	280568

## 179NXXL-8D

- Extra deep tool trolley

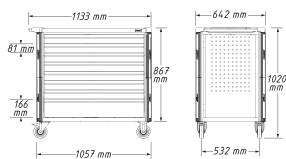

Stainless steel work surface  
EDELSTAHL®  
Rostfrei

Made in Germany

HAZET No.	Lateral door and socket strip	Number of drawers	EAN-No. 4000896 +
179NXXL-8D	–	8	242931
179NXXL-8D/3	✓	8	245178

## 179NW

- Mobile work bench



30 mm wood multiplex birch work surface, oiled on both sides, replaceable



3/3+ drawer width with storage compartment

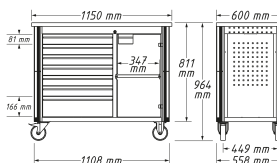

Made in Germany

HAZET No.	Equipment	EAN-No. 4000896 +
179NW-7	6 flat drawers, 1 high heavy-duty drawer and one storage compartment	219629
179NW-8	8 flat drawers and one storage compartment	222933

## Service trolley

- Swivelling pillars



Made in Germany

HAZET No.	Length x width x height mm	Lowest height mm	EAN-No. 4000896 +
① 166N	650 x 415 x 965	500	004959
② 166C	725 x 398 x 1098	642	072286

## Service trolley

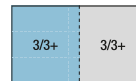

Made in Germany

HAZET No.	Length x width x height mm	Side walls	EAN-No. 4000896 +
① 167-3	890 x 542 x 899	–	205332
② 167-3S	888 x 541 x 899	✓	207206

179NW-7/320 with 320 expert tools



Perfect problem solver - saves time and money!



Including  
**HiPer**  
90 teeth · 4° ·  
1000 Nm (1/2")

179NW-7/320  
EAN-No. 4000896279043

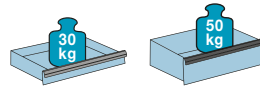

**NEW!**

320



163-513/122N 6.3 1/4 10 3/8 12.5 1/2 16 3/4



30 mm wood multiplex birch work surface, oiled on both sides, replaceable

Assortment



163-526/41N



163-672/46



Including 2128N-1



163-609/61



163-372/25



179NXL-8/388 with 388 commercial vehicle expert tools



The tool set for real workhorses!

4/3+

Including  
**HiPer**  
90 teeth · 4° ·  
1000 Nm (1/2")

179NXL-8/388  
EAN-No. 4000896268801



163-522X50



163-406/20 20 3/4 19 - 60 mm

163-621/53



163-622/3  
163-623/4  
163-624/3

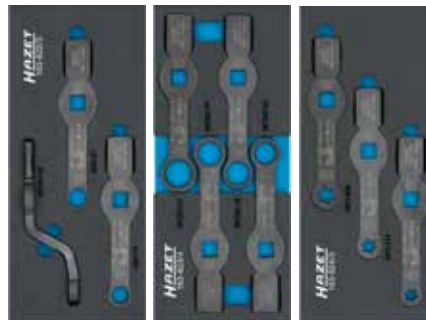

163-619/35



163-618/184



163-620/42



Stainless steel work surface  
EDELSTAHL  
Rost frei

388



**NEW!**

Made in Germany

Incl. new  
3/4" impact adapter,  
quick coupler

Assortment



More information on pages 44 - 45



163-612/40

1/2 20 3/4 24 mm



179NXL-8S1/515 with 515 expert tools

515

Including  
**HiPer**  
90 teeth · 4° ·  
1000 Nm (1/2")

4/3+

163-644/266



163-646/61

s 6 x 7 – 34 x 36 mm, s 6 – 32 mm; s 10 – 22 mm,  
 s 8 – 19 mm, 762-15, 762-16



163-647/45



163-650/60



**NEW!**

Stainless steel work surface  
EDELSTAHL®  
**Rost frei**

Assortment



179NXL-8S1  
Made in Germany  
Wide design: 959 mm



Made in Germany

Incl. new  
3/4" impact adapter,  
quick coupler

More information on pages 44 - 45

Made in Germany



762-15  
Clamping range:  
33 mm  
Length: 150 mm

762-26  
Clamping range: 56 mm  
Length: 260 mm

**Incl. grip pliers wrench**

More information on page 16

179NXL-8S1/515  
EAN-No. 4000896275915

163-645/45



163-648/38



## 179NXXL-8/399 with 399 expert tools

5/3+

Including  
**HiPer**  
90 teeth · 4° ·  
1000 Nm (1/2")

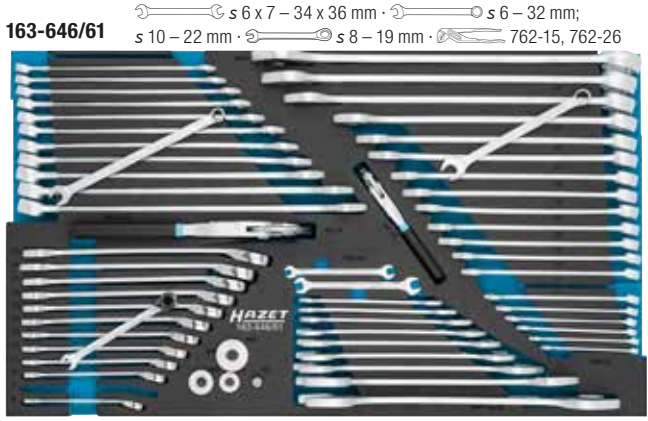

**Incl. grip pliers wrench**

More information on page 16



179NXXL-8/399  
EAN-No. 4000896279128







3/4" Socket set

**3/4" Reversible ratchet, extendable**

More information on page 19

20 3/4 20 3/4



Made in Germany

163-681/21

EAN-No. 4000896279326

Assortment



**NEW!**

21

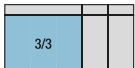

Combination wrench set

**NEW!**

37

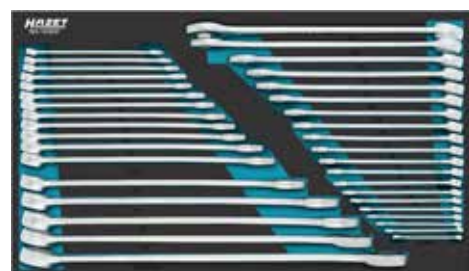

163-679/37

EAN-No. 4000896279388

Assortment

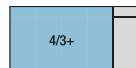

Wrench set

42

s 5,5 - 32 mm, s 8 - 32 mm



163-620/42

EAN-No. 4000896268962

Assortment



Screwdriver set

35



Made in Germany

163-619/35

EAN-No. 4000896269716

Assortment

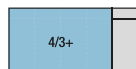

Pliers set

**NEW!**

12



163-678/12

EAN-No. 4000896279425

Assortment

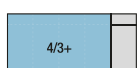

Tool set

**NEW!**

37



163-680/37

EAN-No. 4000896279340

Assortment

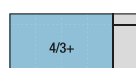

## Protective mats

- Robust PVC protective mat for stainless steel work surface
- Black matt, high-quality surface
- Oil- and solvent-resistant
- Thickness: 2 mm

**NEW!**

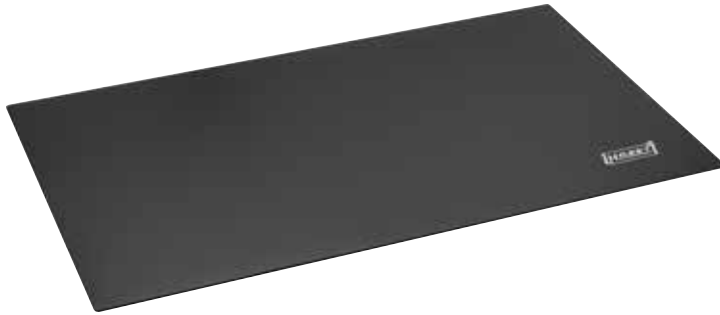

HAZET No.	Protective mat for tool trolley "Assistant"	Dimensions (mm)	EAN-No. 4000896 +
179NX-39	179NX	439 x 554 x 2	279647
179NXL-39	179NXL	439 x 730 x 2	279623
179NXXL-39	179NXXL	439 x 904 x 2	279661
179NXXLD-39	179NXXLD	564 x 904 x 2	279685

HAZET No.	Designation	EAN-No. 4000896 +
161N-3D	Cable drum (without holder)	237517
161N-3D/2	Cable drum (incl. holder)	237654
161N-5D	Socket strip for 179NXXL-8D	245161
161T-176N/4	Separation sheet set for flat drawer	265619
161T-176N/4H	Separation sheet set for high drawer	265596
176N-26	Perforated tool panel for 176N-7	265633
176N-261	Mounting rail	265657
179-35	Can holder, for 3 cans	141074
179N-21	Lateral door for 179N · 179NX · 179NXL · 179NXXL	215553
179N-21D	Lateral door for 179NXXL-8D	245154
179N-26	Perforated tool panel for 179N · 179NX	215522
179N-33	Paper bin including holder	236206
179N-35	Can holder, for at least 4 cans	224258
179N-40	Basic fixture for 179N · 179NX · 179NXL · 179NXXL · 179NXXL-8D	215591

HAZET No.	Designation	EAN-No. 4000896 +
179N-42	Laptop holder for 179N · 179NX · 179NXL · 179NXXL	215621
179N-45	Tablet holder	224005
179N-46	Impact wrench holder	224265
179N-50	Bracket for an L-Boxx	243068
179N-51	Bracket set for two L-Boxxes	243051
179N-510	Bracing surface for L-Boxx bracket 179N-51	243075
179N-75	Vice fastening for 179N · 179NX · 179NXL · 179NXXL	241835
179ND-75	Vice fastening for 179NXXL-8D · 179NXXL-8D/3	252343
179NW-11	Machinist's vice fastening set	221967
179NXL-26	Perforated tool panel for 179 NXL	215539
179NXXL-26	Perforated tool panel for 179NXXL	215546
180-24	Document holder	110827
180-34	Holder for paper reel	120840
2175N	Machinist's vice	013685

161N-3D/2



180-24



179N-42



179NXL-26

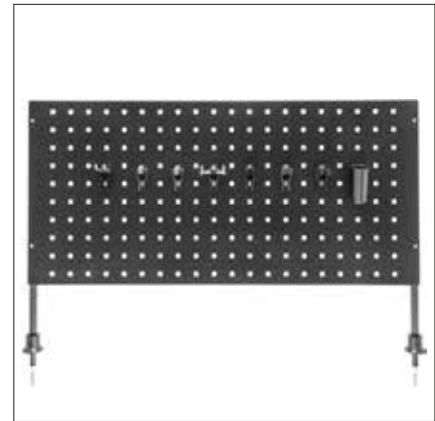

179N-35



180-34



179N-33



179N-75





**Made in Germany**

**HIGH COMPETENCE IN THE DEVELOPMENT AND PRODUCTION OF WRENCHES FOR OVER 150 YEARS**

► Drop forged in dies developed and produced by HAZET

### Combination wrench set

21

- Long design
- Surface: chrome-plated, polished head
- DIN 3113 form A, ISO 3318, ISO 7738



**Made in Germany**

**600N/21**

EAN-No. 4000896023356

s 6 · 7 · 8 · 9 · 10 · 11 · 12 · 13 · 14 · 15 · 16 · 17 · 18 · 19 · 21 · 22 · 24 · 27 · 30 · 32 · 34 mm

### Ratcheting combination wrench set

6

- Ratchet function with one-hand reversing switch
- Fine-tooth, 72 teeth, operating angle 5°, 13° angled
- Surface: chrome-plated



**Large sizes!**

**606/6-1**

EAN-No. 4000896175178

s 21 · 22 · 24 · 27 · 30 · 32 mm

### Ratcheting combination wrench set

5

- Ratchet function with one-hand reversing switch
- Fine-tooth, 72 teeth, operating angle 5° (s 8 mm: 60 teeth, operating angle 6°) 13° angled
- Surface: chrome-plated



**606/5**

EAN-No. 4000896177998

s 8 · 10 · 13 · 17 · 19 mm

### 1/4" · 3/8" · 1/2" Adapter set

4

- For ratcheting combination wrenches
- Contents:**
- 3 ratcheting combination wrench adapters with retaining knob:
    - 10 mm ● to 63 1/4 · 13 mm ● to 10 3/8 · 19 mm ● to 128 1/2
  - 1 screwdriver bit adapter: 10 mm ● to 63 1/4



**606/4SPC**

EAN-No. 4000896127399

### Combination wrench · extra-long · slim design

10 12 13

- Loading capacity at least twice as high as DIN
- At least 25% longer than comparable standard wrenches – for greater power transmission
- Better accessibility with low-lying screw connections
- Shank with extra sturdy double-T-profile



**Made in Germany**

HAZET No.	■	S mm	EAN-No. 4000896 +
600LG/10	10	10 · 11 · 12 · 13 · 14 · 15 · 16 · 17 · 18 · 19	218424
600LG/12	12	10 · 11 · 12 · 13 · 14 · 17 · 19 · 22 · 24 · 27 · 30 · 32	202492
600LG/13	13	10 · 11 · 12 · 13 · 14 · 15 · 16 · 17 · 18 · 19 · 21 · 22 · 24	218417





## 1/4" SmartHolder

### 1/4" SmartHolder

- 18 screwdriver bits, short, 25 mm:
  - s 0.6 x 4.5 mm
  - PH1 · PH2 · PH3
  - PZ1 · PZ2 · PZ3
  - s 3 · 4 · 5 · 6 · 8 mm
  - T10 · T15 · T20 · T25 · T30 · T40
- 11 screwdriver bits long, 50 mm:
  - s 0.8 x 5.5 mm
  - PH2
  - PZ1 · PZ2
  - s 3 · 4 · 5 · 6 mm
  - T20 · T25 · T30
- 6 sockets, hexagon:
  - s 5.5 · 7 · 8 · 10 · 12 · 13 mm
- Mini solid steel fine-tooth reversible ratchet
- Bit holder with magnet
- Adapter 6.3 = 1/4" → 6.3 = 1/4"
- Adapter



reddot winner 2023



39



Incl. 1/4" mini solid steel fine-tooth reversible ratchet 863MB

6.3 1/4"



2300SH-1

EAN-No. 4000896246588



## 1/4" SmartCase

### 1/4" Socket set



Assortment



2200SC-2

EAN-No. 4000896239603



50

### 1/4" Socket and screwdriver bit set



Assortment



2200SC-32

EAN-No. 4000896244546



59

## SmartRail

### SmartRail · flexible plastic plug-in rail

- Magnetic underside ensures grip on all ferrous surfaces, e.g. on tool trolleys, tool panels, machines, lifting platforms and in metal drawers
- Durable, robust twist lock for a tight fit and instant access
- Easy to clean



With 5x 1/2" square sockets, empty

900SR-5

EAN-No. 4000896244508



With 8x 1/2" square sockets, empty

900SR-8

EAN-No. 4000896244515



**Slot / Phillips set with holder**

- Practical holder with keyhole for wall mounting



**811SH-1/7**  
EAN-No. 4000896264605

4 x		0,5 x 3,0 · 0,8 x 4,0 · 1,0 x 5,5 · 1,2 x 6,5 mm
2 x		PH1 · PH2

**TORX® set**



**811T/6**  
EAN-No. 4000896258406



6 x		T10 · T15 · T20 · T25 · T27 · T30
-----	--	-----------------------------------

**Set with impact cap**



**811S/5**  
EAN-No. 4000896258420



3 x		0,8 x 4,5 · 1,0 x 5,5 · 1,2 x 7 mm
2 x		PH 1 · PH 2

**1/4" Ratcheting bit screwdriver with built-in magazine**

- Screwdriver bits can be accommodated without operating the sleeve – screwdriver bit can also be inserted in locked state
- The screwdriver bit is removed simply by pulling it – quick bit change with only one hand
- Strong permanent magnet to hold the screwdriver bits securely in place
- Total length: 255 mm

**Facelift!**



Incl. extension (80 mm) 810R-2

**EJECT!**

**811R-4**  
EAN-No. 4000896270583

**Set includes 12 screwdriver bits**

			0,8 x 5,5 mm
			PH2 · PH3
			s 3 · 4 · 5 · 6 mm
			T15 · T20 · T25 · T27 · T30

**Ratchet with free running function**



Quick bit change with just one hand



**1/4" Double bit holder with T-handle**

- Total length: 97 mm
- Blade length: 7.5 mm and 63 mm



**Made in Germany**

**866BH-4**  
EAN-No. 4000896249329

**1/4" Spin type speeder with T-handle**

- Short design
- Length: 134 mm
- Blade length: 100 mm



**866-4**  
EAN-No. 4000896242979

**1/4" Telescopic screwdriver bit holder with T-handle**

- Total length: 241 – 394 mm
- Blade length: 205 – 358 mm



**Made in Germany**

**866BH-14**  
EAN-No. 4000896249336

**1/4" Spin type speeder with T-handle**

- Long design
- Length: 300 mm
- Blade length: 266 mm



**866-10**  
EAN-No. 4000896241842



**Made in Germany**

## OUR INNOVATIONS ARE MADE IN GERMANY

- ▶ From the idea for a new product, through development to series production
- ▶ All this takes place here in Remscheid

### Grip pliers wrench

- Compact and at the same time highly resilient
- In four different lengths: 125 · 150 · 180 · 260 mm
- Convenient – thanks to quick adjustment with proven HAZET tip / step lever function
- One-hand presetting possible
- Permanent laser-marked scaling for easy setting and reading
- High corrosion resistance due to chrome-plated, easy-to-clean pliers legs
- Heavy-duty pliers legs made of case-hardened chrome vanadium steel
- Comfortable grip thanks to double dip coating – lies well in the hand
- Fine detent distance enables any wrench size in the clamping range

### Universal pliers

- Compact and at the same time highly resilient
- In four different lengths: 125 · 150 · 180 · 260 mm
- Convenient – thanks to quick adjustment with proven HAZET tip / step lever function
- Long service life due to extremely hard jaw serration
- More force thanks to teeth offset against the direction of rotation
- Precise latching with the aid of laser-cut serration
- Heavy-duty pliers legs made of case-hardened chrome vanadium steel
- Phosphatised surface
- Pleasant to grip thanks to double dip coating – lies well in the hand
- Fine detent distance enables any wrench size in the clamping range

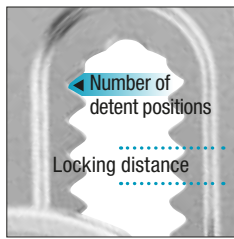

**Made in Germany**

HAZET No.	Length mm	Detent distance mm	Number of detent positions	Clamping range mm	EAN-No. 4000896 +
762-12	125	2	12	26	249800
762-15	150	2	15	33	249640
762-18	180	2	19	42	249787
762-26	260	2,5	20	56	249664

**Made in Germany**

HAZET No.	Length mm	Detent distance mm	Number of detent positions	Clamping range mm	EAN-No. 4000896 +
760-12	125	2	13	27	249749
760-15	150	2	14	34	249688
760-18	180	2	17	36	249763
760-26	260	2,5	17	50	249701

### Protective jaws

Contents: – 3 pairs

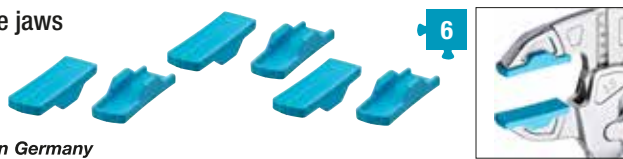

**Made in Germany**

762-018/6	Protective jaws for grip pliers wrench 762-18	259861
762-026/6	Protective jaws for grip pliers wrench 762-26	259885

### High-leverage diagonal cutter

- Performance class H (piano wire, hardened steel wire)
- Leverage reduces force expenditure by 40%
- Opening spring and locking
- Induction-hardened cutting edges with grind
- Cutting edge hardness: 64 HRC
- Handles with dip coating
- DIN ISO 5747



**Made in Germany**

HAZET No.	Length mm	Rm N/mm <sup>2</sup> ○ 800	Rm N/mm <sup>2</sup> ● 1600	Rm N/mm <sup>2</sup> ● 1600	EAN-No. 4000896 +
1804N-2	160	3	2,7	2,2	086276

### Snipe nose pliers

- Working in areas with restricted access
- Flat round shape
- Extra-long design
- Handles with dip coating



**Made in Germany**

HAZET No.	Length mm	Jaw shape	EAN-No. 4000896 +
① 1841A-280	280	Straight design	051489
② 1841B-280	280	Curved design (45°)	051694

### Commercial vehicle double-handled pry bar

- Impact-resistant, ergonomic plastic handle, allows two-hand operation
- Hexagon blade passes through the handle
- Solid impact head for high loads
- Hardened and tempered
- Length: 1116 mm



**2166-4**  
EAN-No. 4000896161072



### Sledge hammer

- Particularly safe thanks to double wedge (1 ring wedge + 1 wooden wedge)
- Hickory handle
- DIN 1042



**Made in Germany**

HAZET No.	Length mm	Hammer head [g]	Weight [g]	EAN-No. 4000896+
2139-1	600	3000	3510	196197
2139-2	800	5000	5730	196203

### Plastic hammer · non-rebound

- **Non-rebound:** due to steel ball filling in the centre part of the hammer head and precisely matched material of the impact heads
- Replaceable polyurethane heads,
- Splinter and crumble-free
- Gentle and careful working
- Abrasion-proof, long service-life
- PVC handle, resistant to oil and gasoline



#### Spare heads (pair)

**Made in Germany**

**Made in Germany**

HAZET No.	Length mm	Ø mm	EAN-No. 4000896+
1953N-40	123	40	227051
1953N-60	163	60	227037

HAZET No.	Spare heads for	Ø mm	EAN-No. 4000896+
1953N-040	1953N-40	40	227792
1953N-060	1953N-60	60	227778

### Drift pin set with hand guard · long

- Safety impact cap avoids material splintering and deformations
- High-alloy tool steel, consistently hardened
- Gold-coloured immersion-lacquered
- All metal parts are GS tested
- Ergonomically shaped 2-component hand guard:
  - Significantly reduced risk of injury
  - Damping effect (less stress to the hand from impacts)
  - Secure grip

**Contents:**  
8 · 10 · 12 · 14 · 16 mm



Including tool holder!

**5 NEW!**

**Made in Germany**  
**751LHS/5-1**  
EAN-No. 4000896269440



### Pry bar set

- Flat and bevelled tips allow application in areas with restricted access
- Solid square blades guarantee high power transmission

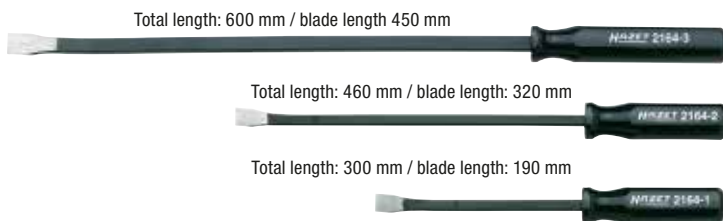

Total length: 600 mm / blade length 450 mm

Total length: 460 mm / blade length: 320 mm

Total length: 300 mm / blade length: 190 mm

**2164/3**  
EAN-No. 4000896080281



### 3 Brass mandrel

- Knocking bushings, bearing rings, bolts, etc. in and out
- Length: 200 mm
- Diameter: 20 mm



**Made in Germany**  
**2534**  
EAN-No. 4000896016365





**Made in Germany**

**HIPER FINE-TOOTH REVERSIBLE RATCHETS**

- ▶ Developed and produced by HAZET "Made in Germany"
- ▶ High permanent load for durability
- ▶ Enormously increased performance



**ONLY GENUINE WITH 90 TEETH AND 4° OPERATING ANGLE HIGH PRECISION!**



- ① Pawl
- ② Ratchet wheel
- ③ Shift lever
- ④ Housing
- ⑤ 2-component handle

6.3 1/4 6.3 1/4 10 3/8 12 1/2 1/2



**DOUBLE PRECISION IN PERFECTION!**

- ▶ HAZET internal quality standards guarantee loading capacity far beyond the standard requirements
- ▶ 90 teeth, 4° fine toothed for confined spaces
- ▶ Locking function of the lever offers protection against unwanted switching

**DIN/HiPer performance comparison using the example of 916 HP**

**Peak load**  
DIN 3122:2017-04  
(static load)

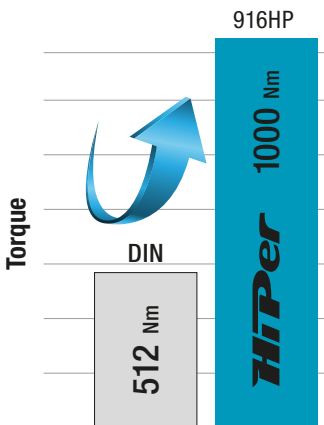

**Durability | Permanent load**  
ISO 3315:2018-05  
(dynamic load)

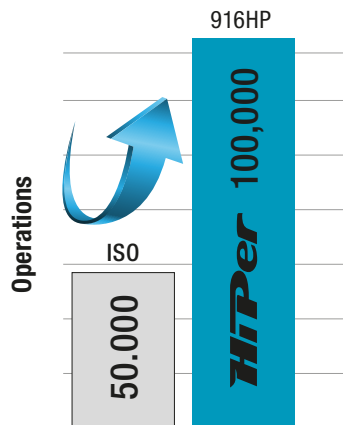

**Static and dynamic – double precision in perfection!**



**Made in Germany**

HAZET No.	Size	Nm max	Length mm	EAN-No. 4000896 +
<b>Our classics!</b>				
①	863HPB 6.3 1/4	120	116	235346
②	863HP 6.3 1/4	120	116	226917
③	8816HP 10 3/8	400	200	235063
④	916HP 12 1/2 1/2	1000	275	213894
⑤	916HPL 12 1/2 1/2	1000	415	219209
⑥	916HPLG 12 1/2 1/2	1000	414 – 614	233076
<b>Short design!</b>				
⑦	916HPK 12 1/2 1/2	400	200	244379
<b>With safety locking!</b>				
⑧	863HPS 6.3 1/4	100	116	237234
⑨	8816HPS 10 3/8	340	200	237241
⑩	916HPS 12 1/2 1/2	850	275	237258



**Made in Germany**

**MORE REACH. MORE CONTROL.**

- ▶ With our new HAZET reversible ratchet you can reach even tight places effortlessly and apply force exactly where you need it. Compact, flexible and ready for any application.

**CONTINUOUSLY ADJUSTABLE FROM 730 TO 1130 MM (WITHOUT PRE-FIXED DETENT POINTS)!**

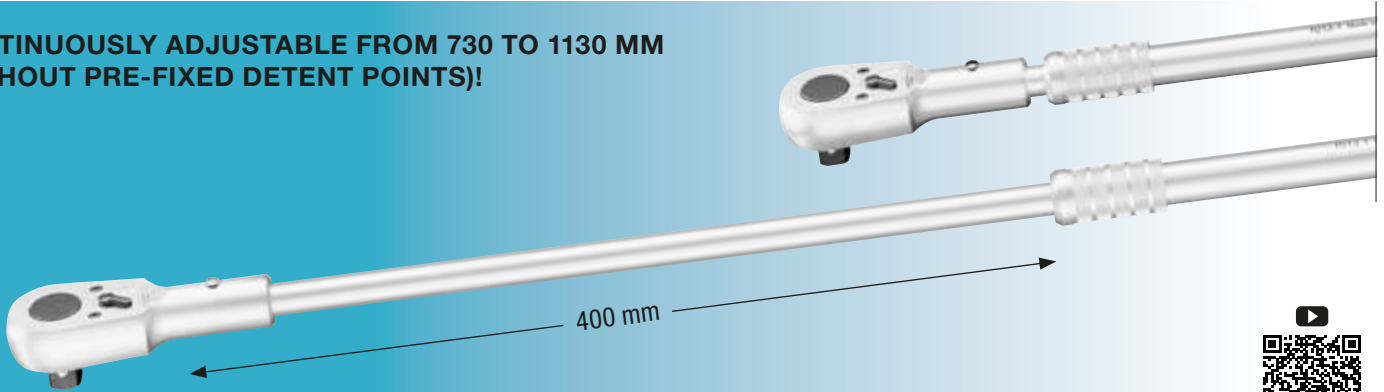

**3/4" Reversible ratchet, extendable**

- Continuously adjustable from 730 to 1130 mm (without pre-fixed detent points)
- Torque max.: 1800 Nm
- Long lever arm for powerful work and more torque with less effort
- Safe working without extension tube
- Easy fixation with knurled clamping nut
- Twist protected handle ensures optimum force transmission without slipping
- HAZET 2-component handle for improved grip and secure hold
- Extendable: 400 mm
- Number of teeth: 32
- Operating angle: 11.25°
- For manual operation
- Surface: chrome-plated
- Ratchet standard: DIN 3122 / ISO 3315

- Contents:**
- Handle, extendable 1013-1
  - 3/4" Reversible ratchet head 1016



20 3/4"

**NEW!**



**1800 Nm!**



**Suitable for large sockets with 3/4" drive and high loads!**

**Made in Germany**  
**1016LG**  
 EAN-No. 4000896276929



**Handle, extendable**

- Continuously adjustable from 610 to 1010 mm (without pre-fixed detent points)
- For 3/4" reversible ratchet head 1016



**NEW!**

**Made in Germany**  
**1013-1**  
 EAN-No. 4000896273546

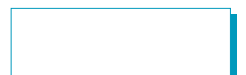



**Made in Germany**

**OUR WORKSHOP CLASSICS!**

- ▶ Series with large measuring range: 1 – 800 Nm
- ▶ Tested in accordance with DIN EN ISO 6789-2:2017 with calibration certificate and serial number
- ▶ HAZET's own Service Centre for the best aftersales service

**USER-FRIENDLY REVERSIBLE RATCHET**

- ▶ 10 versions with
  - 1/4" - 3/8" - 1/2" - 3/4"
 reversible ratchet
- ▶ Accuracy  $\pm 3\%$  of the scale value (5107  $\pm 4\%$ ) in direction of actuation



**SYSTEM 5000-3CT**  
 1/4" - 3/8" - 1/2" - 3/4" - 1" Torque wrench  
 1 - 800 Nm,  $\pm 3\%$  (except 5107-3CT,  $\pm 4\%$ )

6.3 1/4" 10 3/8" 12.5 1/2" 20 3/4"



**Made in Germany**

HAZET No.	Output	Nm range	Release accuracy tolerance $\pm\%$	Length mm	EAN-No. 4000896 +
5107-3CT	6.3 1/4"	1 - 9	4	234	218875
5108-3CT	6.3 1/4"	2,5 - 25	3	234	218882
5110-3CT	10 3/8"	10 - 60	3	320	218899
5111-3CT	10 3/8"	20 - 120	3	375	235384
5120-3CT	12.5 1/2"	10 - 60	3	320	218905
5121-3CT	12.5 1/2"	20 - 120	3	421	218912
5122-3CT	12.5 1/2"	40 - 200	3	519	219001
5123-3CT	12.5 1/2"	60 - 320	3	628	218998
5143-3CT	12.5 1/2"	100 - 400	3	790	235407
5145-3CT	20 3/4"	300 - 800	3	1271	218929

**No more turning back!**

Setting instructions



**SYSTEM 6000-1CT**  
 3/4" · 1" Torque wrench 400 – 1600 Nm,  $\pm 3\%$

- Accuracy  $\pm 3\%$  of the scale value (in direction of actuation)
- Incl. bag for safe storage
- 2-component handle
- Viewing window for locking

**Made in Germany**

HAZET No.	Output	Nm range	Release accuracy tolerance $\pm\%$	Length mm	EAN-No. 4000896 +
6150-1CT	20 3/4"	400 - 1000	3	1789	141067
6160-1CT	25 1"	600 - 1600	3	2455	155316





## HIGH-VOLTAGE TOOLS WITH PROTECTIVE INSULATION

- ▶ For safe and hazard-free working
- ▶ For use up to 1000 volts
- ▶ Special HAZET 1000 V protective insulation

### 1/2" Tool set · with protective insulation

- Working on high-voltage systems
- In HAZET L-Boxx – all tools ready to hand
- Operation of live components such as batteries, capacitors or distributors
- The use of two extensions with protective insulation enables simple and safe installation and removal of e.g. the battery
- Highest level of safety through constant quality control of the tools
- For electric trucks from e.g. **MERCEDES-BENZ · MAN · DAF · RENAULT · SCANIA · Volvo** as well as electric city buses such as e.g. **MERCEDES-BENZ · MAN · VDL · IVECO · SOLARIS · Volvo · SCANIA · BYD · SILEO · LIKKER · COBUS · MELLOR · KARSAN · IRIZAR · EBUSCO · TEMSA · EURABUS · EASYMILE · NAVJA · LOCAL MOTORS · HEULIZ**



**916KV** · 125 1/2  
Length: 260 mm

**1816VDE-222**  
Length: 160 mm

**630KV** · ●  
s 13 · 17 · 19 mm

**900KV** · 125 1/2  
s 13 · 14 · 15 · 16 · 17 · 19 mm

**810VDE** · ●  
0.4 x 2.5 · 0.5 x 3 · 0.6 x 3.5 · 0.8 x 4 mm

**1802VDE-22**  
Length: 180 mm

**1841AVDE-22**  
Length: 160 mm

**450KV-5** · ●  
s 13 · 17 · 19 mm

**917KV-5** · 125 1/2 125 1/2  
Length: 140 mm

**810VDE** · ●  
PH 1 · PH 2 · PH 3

**1805VDE-44**  
Length: 200 mm

**1860VDE-11**  
Length: 160 mm

**1804VDE-33**  
Length: 208 mm

**918KV-10** · 125 1/2 125 1/2  
Length: 264 mm

**196V-10/5**    **196V-20/5**  
**2156VDE-2**

Universally applicable on all trucks and buses, as well as agricultural and construction machinery with electric drives!

**150/39**  
EAN-No. 4000896239641

### 3/8" High-voltage tool set, with protective insulation

- Produced according to current DIN specifications – optimum protection and highest level of safety thanks to constant quality control
- Recess for retrofitting with 3/8" torque wrench, with protective insulation 5109KV

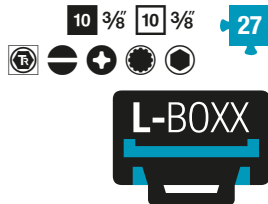

Made in Germany  
**150/27**  
EAN-No. 4000896245550



### High-voltage screwdriver set for electricians with protective insulation

- Non-slip HAZET 3-component handle, allows high power transmission with hanging hole
- Voltmeter (839P), 220 – 250 V according to DIN VDE 0680-6

- Contents:**
- 811KV-PH1, -PH2
  - 811KV-25, -35, -40
  - 839P



**811KV/6**  
EAN-No. 4000896268146

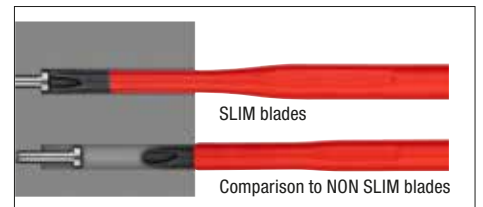



# Twin Turbo

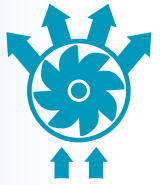

## THE STRONGEST HAZET IMPACT WRENCH SERIES EVER!

- ▶ 1/2" · 3/4" · 1" Twin Turbo impact wrenches to 4100 Nm power
- ▶ Twin Effect – More power in less time!
- ▶ Two air inlets and four air outlets
- ▶ 8-blade air motor with 25% higher impact performance ensures maximum torque
- ▶ HAZET's own Service Centre for the best aftersales service

### Extremely compact

#### Max. loosening torque: 550 Nm

- High performance twin hammer mechanism
- Recommended torque: 450 Nm
- Sound power level (at working pressure): 103.9 db(A) Lp W
- Sound pressure level (at working pressure): 92.9 dB(A) Lp A
- Vibration acceleration: 7.64 m/s<sup>2</sup>
- Revolutions per minute: 8000
- Air requirement: 113 l/min
- Loosening torque (max.) determined with screw size M: 16
- Weight: 1.1 kg
- Housing length: 70 mm



1/2"



12<sup>5</sup> 1/2"

Can be used with 900SK/10

More information on page 47



9012PTT  
EAN-No. 4000896252732



### Short: only 128 mm

#### Max. loosening torque: 2200 Nm

- High performance twin hammer mechanism
- Recommended torque: 948 Nm
- Sound power level (at working pressure): 110.7 db(A) Lp W
- Sound pressure level (at working pressure): 99.7 dB(A) Lp A
- Vibration acceleration: 8.69 m/s<sup>2</sup>
- Revolutions per minute: 8300
- Air requirement: 147.2 l/min
- Loosening torque (max.) determined with screw size M: 16
- Weight: 1.6 kg
- Housing length: 128 mm



1/2"



12<sup>5</sup> 1/2"

9012TT  
EAN-No. 4000896226924



### 3/4" Impact wrench in 1/2" housing size

#### Max. loosening torque: 1890 Nm

- High performance twin hammer mechanism
- Recommended torque: 900 Nm
- Sound power level (at working pressure): 110.3 db(A) Lp W
- Sound pressure level (at working pressure): 99.3 dB(A) Lp A
- Vibration acceleration: 11.39 m/s<sup>2</sup>
- Revolutions per minute: 8000
- Air requirement: 150 l/min
- Loosening torque (max.) determined with screw size M: 26
- Weight: 1.7 kg
- Housing length: 128 mm

9013MTT compared with 9013TT



3/4"



20 3/4"

9013MTT  
EAN-No. 4000896258062



**Short: only 184 mm**

**Max. loosening torque: 4100 Nm**

- High performance twin hammer mechanism
- Recommended torque: 1890 Nm
- Sound power level (at working pressure): 110.5 dB(A) Lp W
- Sound pressure level (at working pressure): 99.5 dB(A) Lp A
- Vibration acceleration: 10.69 m/s<sup>2</sup>
- Revolutions per minute: 5200
- Air requirement: 243.5 l/min
- Loosening torque (max.) determined with screw size M: 32
- Removable handle, 360° adjustable
- Weight: 4.5 kg
- Housing length: 184 mm



**Long spindle: 186 mm**

**Max. loosening torque: 3800 Nm**

- High performance twin hammer mechanism
- Recommended torque: 1758 Nm
- Sound power level (at working pressure): 113.5 dB(A) Lp W
- Sound pressure level (at working pressure): 102.5 dB(A) Lp A
- Vibration acceleration: 9.02 m/s<sup>2</sup>
- Revolutions per minute: 5200
- Air requirement: 243 l/min
- Loosening torque (max.) determined with screw size M: 32
- Removable handle, 360° adjustable
- Weight: 5.5 kg
- Housing length: 184 mm



**Strong and handy**

**Max. loosening torque: 4100 Nm**

- High performance twin hammer mechanism
- Recommended torque: 1898 Nm
- Sound power level (at working pressure): 112.9 dB(A) Lp W
- Sound pressure level (at working pressure): 101.9 dB(A) Lp A
- Vibration acceleration: 19.11 m/s<sup>2</sup>
- Revolutions per minute: 5200
- Air requirement: 235 l/min
- Loosening torque (max.) determined with screw size M: 32
- Removable handle, 360° adjustable
- Weight: 4.6 kg
- Housing length: 184 mm



**Long spindle: 240 mm**

**Max. loosening torque: 3850 Nm**

- **Short, compact design**
- High performance twin hammer mechanism
- Recommended torque: 1627 Nm
- Sound power level (at working pressure): 113.5 dB(A) Lp W
- Sound pressure level (at working pressure): 102.5 dB(A) Lp A
- Vibration acceleration: 17.31 m/s<sup>2</sup>
- Revolutions per minute: 4600
- Air requirement: 235 l/min
- Loosening torque (max.) determined with screw size M: 32
- Removable handle, 360° adjustable
- Weight: 5.9 kg
- Housing length: 184 mm



### Max. loosening torque: 1200 Nm

- Compact design for work in confined spaces
- Single hammer striking mechanism
- Revolutions per minute: 8800
- Air requirement: 127.4 l/min
- Sound pressure level (at working pressure): 92.2 dB(A) Lp A
- Vibration acceleration: 13.49 m/s<sup>2</sup>
- Weight: 1.3 kg



1/2"

Extra short – only 81 mm

9012M-1

EAN-No. 4000896218356



HAZET No.	Silicone protective cover	EAN-No. 4000896 +
9012M-1-S	Suitable for 9012M-1	222735

125 1/2"

### Max. loosening torque: 3400 Nm

25 1"

- Output designed with hole for pinning, as well as a nut-driver holder ring
- Operation optimised on both sides for left and right handed users
- One-hand reversing switch
- Reduced vibrations
- Forward/reverse: three stage
- Tightening torque (max.) 2712 Nm
- Working pressure: 6.3 bar
- Rotation speed: 5500 U/min
- Air requirement: 283 l/min (4.7 l/sec)
- Sound pressure level (at working pressure): 103.5 dB(A) Lp A



1"

1"

HAZET No.	Design	Length mm	EAN-No. 4000896 +
9014PS-1	Short spindle	382	222490
9014P-1	Long spindle, 240 mm	587	218332

### Max. loosening torque: 54 Nm

- The open 17 mm inside hexagon means it is also possible to work on extra long threads
- Can be used for 1/4", 3/8" and 1/2" by replacing the ratchet heads
- Sound power level (at working pressure): 93.4 db(A) Lp W
- Sound pressure level (at working pressure): 82.8 dB(A) Lp A
- Vibration acceleration: 1.80 m/s<sup>2</sup>
- Revolutions per minute: 400
- Air requirement: 84 l/min
- Weight: 0.48 kg
- Length: 160 mm

17 mm



10 3/8"



6.3 1/4"



6.3 1/4"



Mini and multifunction

4

9023M-1

EAN-No. 4000896227112

### Max. loosening torque: 102 Nm

- For manual retightening with torque values > 270 Nm
- Sound power level (at working pressure): 98 db(A) Lp W
- Sound pressure level (at working pressure): 91 dB(A) Lp A
- Vibration acceleration: 4.53 m/s<sup>2</sup>
- Revolutions per minute: 400
- Air requirement: 113 l/min
- Weight: 1.28 kg, length 280 mm



1/2"

9022SR-1

EAN-No. 4000896170593



Impact ratchet: high work safety thanks to reaction-free impact mechanism!

Pin clutch mechanism

125 1/2"

### Max. loosening torque: 120 Nm

125 1/2"

- For manual retightening with torque values > 400 Nm
- Sound power level (at working pressure): 102.2 db(A) Lp W
- Sound pressure level (at working pressure): 91.2 dB(A) Lp A
- Vibration acceleration: 4.87 m/s<sup>2</sup>
- Revolutions per minute: 200
- Air requirement: 107.6 l/min
- Weight: 1.55 kg, length 285 mm



1/2"

9022-360

EAN-No. 4000896209781



Quiet Mode 30% less noise thanks to the ability to reduce operating noise / Quiet Mode (approx. 10 dB)

360° rotatable operating lever

### Air ratchet

- Reaches even extremely restricted spaces and tolerates high manual retightening forces
- For hand retightening with torque values up to 400 Nm
- Reduced vibrations
- Air inlet: inside thread 12.91 mm (1/2")
- Coupler plug (incl.): 7.2 nominal size
- Working pressure: 6.3 bar
- Sound power level (at working pressure): 104.7 db(A) Lp W
- Vibration acceleration: 5.60 m/s<sup>2</sup>
- Weight (net): 2.1 kg
- Tightening torque (max.): 94.8 Nm
- Air requirement: 99.12 l/min (1.7 l/sec)



1/2"

9022P-XLG

EAN-No. 4000896222513

Extra-long: 551 mm

## Turbo air blow gun

- Cleaning dirty surfaces such as upholstery, dirt from wheel housings, floor mats from animal hair as well as for vehicle preparation, rim and parts cleaning with compressed air and as preparatory cleaning work for the removal and installation of parts
- Swirl nozzle generates a strong air pulse for cleaning even stubborn soiling
- To be used on machinery, vehicles, in workshops, for wood work, in hobby workshops
- Highly practical design
- Air inlet: inside thread 12.91 mm (1/4")
- Coupler plug: nominal size 7.2 (included)
- Hose diameter (recommended): 10 mm
- Max. pressure: 12 bar
- Sound pressure level (at working pressure): 91 dB(A) Lp A
- Sound power pressure (at working pressure): 102 dB(A) Lp W
- Air requirement: 80 l/min (at working pressure)
- Length: 150 mm



Plastic housing protects against scratches



9040T-1

EAN-No. 4000896252626



**Extremely effective due to swirled air impact!**



## Standard nozzle

- Curved tube:  $\varnothing$  8 mm, 100 mm
- Temperature range: -10 to 80 °C
- Max. working pressure: 16 bar
- Length: 247 mm



9040P-1

EAN-No. 4000896209545



## Long nozzle

- Straight tube:  $\varnothing$  8 mm, 300 mm
- Temperature range: -10 to 80 °C
- Max. working pressure: 16 bar
- Length: 420 mm

9040P-2

EAN-No. 4000896209552



Incl.

## 2-way air blow gun with replaceable nozzle

- Choice of air supply at tool head or handle
- Exchangeable nozzles:
  - Short nozzle for areas with restricted access
  - Long nozzle (112 mm) with safety nozzle tip (scratch protection)
- Max. working pressure: 10 bar



9040-4

EAN-No. 4000896176236

## Nozzle set

- Extension of the application ranges of the 2-way air blow gun 9040-4 and the long air blow gun 9040Lg-3/2
- Wide range of applications thanks to various nozzle designs
- Connection (outside thread): 1/8" PF 28

Extendable



### Contents:

- ① Long rubber nozzle 63 mm (scratch protection)
- ② Short rubber nozzle 13 mm (scratch protection)
- ③ Plastic surface nozzle (surface cleaning)
- ④ Metal nozzle with spherical air outlet (non-blocking)
- ⑤ Metal nozzle with safety function (non-blocking)

9040-43/5

EAN-No. 4000896263646

## Air blow gun, extra-long (1085 mm)



9040LG-3/2

EAN-No. 4000896206339

## Nozzles for long air blow gun:

### Venturi nozzle

- 100% increase in air outlet quantity thanks to Venturi effect
- For 9040-4 and 9040 LG-3/2



9040LG-3-01

EAN-No. 4000896241514

### Lateral nozzle 90°

- Nozzle enables lateral blow-out, e.g. for cleaning cooling fins and other hard-to-reach areas
- For 9040-4 and 9040 LG-3/2



9040LG-3-02

EAN-No. 4000896241521

### Cooling system rinser · wash-gun set

- Effective, powerful and solvent-free cleaning of e.g. cooling systems with graduated system cleaning nozzle
- Cleaning without the use of aggressive chemicals or solvents
- Swivel joint at the water connection, helps to avoid "hose spaghetti"
- Continuous independent regulation of water and compressed air supply
- Temperature range: -10 to 40 °C
- Weight (net): 0.4 kg
- Coupler plug (incl.): 7.2 nominal size

**Contents:**

- Water connection variants: 1/2" (13 mm) nipple for water coupling (Gardena system compatible) or 3/4" (20 mm) GHT hose thread
- Jet washing nozzle
- Graded system cleaning nozzle

3



9048P-2/3

EAN-No. 4000896234608

### Grease gun, pneumatic

- Filling capacity: 400 ml
- 360° adjustable body



Length: 172 mm

Length: 230 mm

9042N-1

EAN-No. 4000896176472



### Needle scaler

- Precisely removing rust, etc.
- Pistol shape
- Adjustable needle cover enables maximum utilisation of needles
- Two-piece housing design for easy maintenance
- 19 needles, Ø 3 mm
- 3200 impacts/min
- Length: 321 mm



9035-5

EAN-No. 4000896132355



### Mini needle scaler

- Gentle cleaning of soiled / rusted parts especially cleaning of e.g. brake systems
- Adjustable needle carriage with integrated needle guide ensures long service life
- Suitable for processing stainless steel
- 3000 impacts / minute



Adjustable needle carriage with integrated needle guide ensures long service life

9035M-6

EAN-No. 4000896258109

HAZET No.	Designation	Quantity	EAN-No. 4000896+
9035-050	Spare needles for needle scaler 9035-5, Ø 3 mm	19	139385

HAZET No.	Spare parts	Quantity	EAN-No. 4000896+
9035M-050	Spare needles for mini needle scaler 9035 M-6, Ø 1.3 mm	13	233205

### Vibration chisel set

- Vibration applications on screw connections seized by rust
- Strike rate adjustable in 9 levels up to 2600 strikes/min
- Including keyless drill chuck
- Length: 211 mm
- Height: 189 mm



9035V/5

EAN-No. 4000896213368



HAZET No.	Spare parts	EAN-No. 4000896+
① 9035VH	Combination basic unit (vibration and hammer functions)	214020
② 9035V-01	Semi-circular vibration chisel	214181
③ 9035V-02	Circular vibration chisel	214174
④ 9035V-03	Vibration chisel	214167
⑤ 9035V-04	Vibration chisel	214150

### Chisel hammer set

- Detaching car body sheets with compressed air and for industrial application
- Strike rate adjustable in 9 levels up to 2600 strikes/min
- Including keyless drill chuck
- Length: 211 mm
- Height: 189 mm



9035H/6

EAN-No. 4000896214655

HAZET No.	Spare parts	EAN-No. 4000896+
① 9035VH	Combination basic unit (vibration and hammer functions)	214020
② 9035H-01	Flat chisel	214136
③ 9035H-02	Sheet metal cutting chisel	213924
④ 9035H-03	Pointed chisel	214198
⑤ 9035H-04	Rivet cutting chisel	214143
⑥ 9035H-05	Curve cutting chisel	214525

### Blind rivet gun

- Pneumatic, hydraulic
- Suitable for stainless steel rivets up to 6.4 mm
- Professional riveting, suitable for continuous operation with rivets of up to 6.4 mm made of steel, stainless steel, aluminium and copper
- **Possible rivet sizes:**  
3.0 · 3.2 · 4.0 · 4.8 · 5.0 · 6.0 and 6.4 mm
- 5 nose pieces (one pre-installed): 2.4 · 3.2 · 4 · 4.8 mm



9037N-2

EAN-No. 4000896205578

### Angle grinder

- Power: 700 watts
- Revolutions per minute: 14000
- Length: 371 mm



9033P-8

EAN-No. 4000896190515



HAZET No.	Spare parts		EAN-No. 4000896+
9033P-08/5	Cut-off wheel set	5	201549
9033P-08/25	Cut-off wheel set	25	201402

### Sabre saw

- Support frame, adjustable in height, suitable for double-walled sheet steel
- Increased efficiency with reduction of weight, air consumption, noise generation and vibration
- Direction of air exhaust adjustable
- Suitable for cutting small radii
- Cutting capacity aluminium: 4 mm
- Cutting capacity sheet steel: 3 mm
- Strokes/min.: 9500
- Particularly suitable for cleaning sensor shafts etc., thanks to the attachment of file blades (included in delivery)



9034P-2

EAN-No. 4000896218288



HAZET No.	Spare parts		EAN-No. 4000896+
9034P-R/5	Reciprocal saw blades, chamfered teeth, length: 153 mm	5	218318
9034P-050/5	File set, length: 153 mm	5	218349
9034P-018/5	Saw blades, 93 mm, 18 teeth	5	225958
9034P-024/5	Saw blades, 93 mm, 24 teeth	5	225965
9034P-032/5	Saw blades, 93 mm, 32 teeth	5	225989

### Tyre inflator

- Special rubber housing protects the precise manometer against light impacts
- Filling and measuring the tyre pressure
- Measuring tolerance class: 1.6 (± 0.192 bar)
- Manometer diameter: 63 mm
- Scale value in bar and psi
- Graduation: bar (0.1) / psi (2)
- Metal pressure gauge pointer for optimum readability
- Manometer measuring range: 0(0.2) - 12 bar / 0 (4) - 174 psi
- Handle with operating lever and lateral discharge knob (for one-hand operation)
- Hose length: 500 mm
- Max. pressure: 12 bar (174 psi)
- Integrated suspension hook in the handle
- Air inlet thread: 1/4" BSPT (F)
- Temperature range: -10 to +40 °C
- Housing made of durable POM material
- Incl. German air connection nipple with sealing ring (max. tightening torque 3.5 Nm)



Ø 63 mm

**NEW!**

**Precise pressure gauge!**  
**Flexible hose (length 500 mm) with integrated plug-in nipple!**

9041P-1

EAN-No. 4000896277285

### Tyre inflators

- Manometer measuring range: 0–12 bar, graduation: 0.1 bar
- Max. pressure: 12 bar
- Temperature range: -20 to 60 °C
- Scale values in bar
- Hose with integrated plug-in nipple
- Measuring tolerance: -15 bis 25 °C, 0–4 bar: ±0.08 bar, from 4–12 bar: ±0.16 bar
- Hose length: 1000 mm



Calibration seal

- Manometer measuring range: 0–12 bar, graduation: 0.01 bar
- Max. pressure: 12 bar
- Temperature range: -20 to 50 °C
- Display toggles between bar / PSI / kg/cm<sup>2</sup>
- Hose with plug-in nipple
- Measuring tolerance: -15°C to 25 °C: ±0.1 bar
- Hose length: 400 mm



**Calibrated**

Recalibration possible (not carried out by HAZET)

9041G-1

EAN-No. 4000896212385



Ø 80 mm

**Digital**

9041D-1

EAN-No. 4000896212378



Ø 63 mm

## Hose reel

- Automatic hose reel offers tidiness in the workshop – hose not left lying around, thus reducing the risk of accidents
- For compressed air
- Max. working pressure: 20 bar
- Temperature range: -40 to 60 °C (9040N-10) / -40 to 80 °C (9040N-13)
- Connection hose length: 0.8 m
- Automatic guidance winds the hose neatly
- Braked winding to prevent risk of accidents
- Dimensions: 459 x 378 x 205 mm (9040N-10) / 500 x 418 x 210 mm (9040N-13)

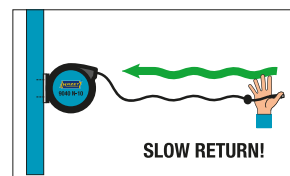
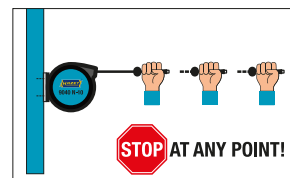

HAZET No.	Inside diameter of the hose mm	EAN-No. 4000896 +
9040N-10	10	206445
9040N-13	13	214648

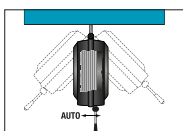

Hose length: 15 m

## Open hose reel

- Automatic hose reel ensures tidiness
- Robust steel design with roller guide
- For compressed air
- Integrated roller inlet
- Swivelling base 180°
- Open design against accumulation of dirt
- Visual inspection of the hose
- Hose inside Ø: 10 mm
- Dimensions: 400 x 186 x 522 mm



90400S-10  
EAN-No. 4000896252602

Hose length: 20 m



## Cable reel

- Automatic cable reel offers tidiness in the workshop – cable not left lying around, thus reducing the risk of accidents
- Including line circuit breaker
- Only suitable for indoor use
- 230 V AC
- Cable: H07RN-F 3 x 2.5 mm<sup>2</sup>
- Cable length: 20 m
- Connecting cable length: 1.5 m
- Automatic guidance winds the hose neatly
- Braked winding to prevent risk of accidents
- Dimensions: 429 x 261 x 175 mm



9040D-2.5  
EAN-No. 4000896214631

Cable length: 20 m



## Compressed air hose

- Wide temperature range
- Complies with DIN EN ISO 5774
- Compressed air hose with quick coupling and connecting nipple
- Pressed coupler bushing / coupler plug
- Burst pressure: 60 bar
- PVC-NBR hybrid polymer compressed air hose

Incl. kink protection on both sides



HAZET No.	Hose length m	Inside diameter of the hose mm	EAN-No. 4000896 +
9040N-1010	10	10	263684
9040N-1020	20	10	263707

## Spiral hose

- High flexible polyurethane hose
- Connecting pieces with 360° swivel joints
- Temperature range: -20 to 60 °C
- Working pressure: 10 bar



HAZET No.	Hose length m	Inside diameter of the hose mm	EAN-No. 4000896 +
9040-7	7,62	6,35	153404
9040S-10	7,62	10	212361

## Safety coupling 0 - 20 bar

- For all air inlet nipples
- Air inlet thread (inside thread): 16.41 mm 3/8"
- Also available for 10 mm hose nipples and with inside and outside thread 1/4" and 3/8"



9000-061  
EAN-No. 4000896195299

Suitable for hose reels 9040N-10 and 90400S-10

## Safety coupling 0 - 50 bar

- For air connection nipple 10 mm
- Air inlet thread (inside thread): 20.95 mm 1/2"



9000-062  
EAN-No. 4000896218936

Suitable for hose reel 9040N-13



## TOTALLY INSPIRING! COMPATIBLE WITH ALL DEVICES OF THE NEW SYSTEM 9500

Our quality makes the difference:

### Reliable performance and long service life!

Flexible contacts ① help to prevent battery wear and extend their service life.

Anti-vibration pads ② and a latching bracket on the head side of the battery ③ minimise vibration and thus increase the service life of the batteries and devices. (No "deflection" of the battery → "wobbling effect")



### Li-ion battery pack, 18 V

- Compatible with all devices in the 9500 series
- Li-ion battery pack 18 V
- LED battery capacity indicator on the battery pack
- Electronic Management System (EMS) protects the battery pack, extends service life and increases efficiency
- Charge and discharge protection
- Dust and splash water protection

#### 5 Ah

- 18 V Li-ion battery pack 5 Ah
- Dimensions (L x W x H): 120 x 75 x 70 mm
- Weight: 0.74 kg

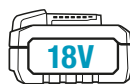

**9500-05**  
EAN-No. 4000896266166

#### 2.5 Ah

- 18 V Li-ion battery pack 2.5 Ah
- Dimensions (L x W x H): 120 x 75 x 50 mm
- Weight: 0.42 kg

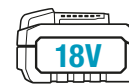

**9500-025**  
EAN-No. 4000896265138

### Quick charger for 18 V rechargeable batteries

- Reaches 80% of the charging capacity after about 30 minutes thanks to a special charging process
- Large LCD display for recognising the state of charge and battery diagnostics (traffic light display)
- Charging time 18 V: 2.5 Ah battery pack approx. 40 minutes, 5 Ah battery pack approx. 45 minutes
- Discharge and overload protection
- Integrated battery pack cooling
- Input voltage: 230 V
- Operating temperature: 0 to 40 °C
- Charging current: 9 A
- Integrated points for wall mounting
- Dimensions (L x W x H): 205 x 150 x 80 mm
- Weight: 0.89 kg

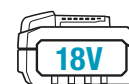

Battery approx. 50%

Battery approx. 80% (ready for use)



**Traffic light display:** Shows state of charge in colour (red-yellow-green) and remaining time until fully charged

**9501-1018**  
EAN-No. 4000896265114

### Battery starter set

- For charging 18 V battery packs

#### Contents

- 2x Li-ion battery packs 9500-05 (5 Ah, 18 V)
- Quick charger 9501-1018



3

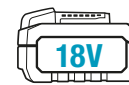

**9500-05/3**  
EAN-No. 4000896265251



### Holder for new RECHARGEABLE BATTERY SYSTEM 9500

- For HAZET tool trolleys "Assistent" 167-3S · 176N · 178N · 179N · 179NX · 179NXL · 179NXXL · 179NXXL-8D and work benches "Assistent" 177W · 179NW · 179NWL
- Simple installation due to attachment function
- Individual fastening to perforated tool panels with square perforation
- Easy-to-clean due to smooth coating

**NEW!**

#### Holder for cordless tools

- Securing with locking clip
- Upper area offers space for chargers and additional batteries
- Square perforation for additional hooks holds up to 3 cordless tools
- Dimensions (L x W x H): 334 x 200 x 152 mm
- Weight approx. 2.2 kg



Made in Germany  
**179N-55**  
EAN-No. 4000896269839

#### Holder for 2 battery packs

- Holds up to 2 batteries
- For HAZET perforated tool boards: 176N-26 · 179N-26 · 179NXL-26 · 179NXXL-26 · 179NW-26
- Dimensions (L x W x H): 180 x 15 x 100 mm
- Weight approx. 0.24 kg



Made in Germany  
**179N-56**  
EAN-No. 4000896269815

#### Holder for HAZET battery charger

- Including securing with locking clip
- Cable protection
- Enables installation of the HAZET battery charger 9501-1018
- For HAZET perforated tool boards: 176N-26 · 179N-26 · 179NXL-26 · 179NXXL-26 · 179NW-26
- Dimensions (L x W x H): 209 x 86 x 174 mm
- Weight approx. 0.42 kg



Made in Germany  
**179N-57**  
EAN-No. 4000896269792

### 1/2" Cordless impact wrench set, 18 V

12S 1/2" 4

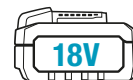

**Contents:**

- 1/2" Cordless impact wrench 9512-600
- 2x Li-ion battery packs 9500-05 (5 Ah, 18 V)
- Quick charger 9500-18



**5 Ah, 18 V**

1/2"



**Max. loosening torque:  
600 Nm**

- 1/2" Cordless impact wrench 9512-600
- Revolutions per minute: 2700
- Weight (without rechargeable battery): 1.17 kg



**9512-600/4**  
EAN-No. 4000896265176



## 1/2" Cordless impact wrench set, 18 V

**Contents:**

- 1/2" Cordless impact wrench 9512-950
- 2x Li-ion battery packs 9500-05 (5 Ah, 18 V)
- Quick charger 9500-18



5 Ah, 18 V

1/2"

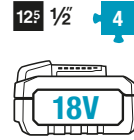

**NEW!**

**Max. loosening torque:  
950 Nm**

**1/2" Cordless impact wrench 9512-950**

- Revolutions per minute: 2450
- Weight (without rechargeable battery): 1.9 kg



9512-950/4

EAN-No. 4000896272716



## 3/4" Cordless impact wrench set, cordless work light, 18 V

**Contents:**

- 3/4" Cordless impact wrench 9513-2100
- 2x Li-ion battery packs 9500-05 (5 Ah, 18 V)
- Quick charger 9501-1018
- Cordless work light 9579-10



5 Ah, 18 V

3/4"

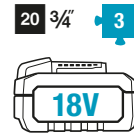

**NEW!**

**Max. loosening torque:  
2100 Nm**

**3/4" Cordless impact wrench 9513-2100**

- Max. loosening torque: 2100 Nm
- Revolutions per minute: 1900
- Weight (without rechargeable battery): 3.1 kg

**Cordless work light 9579-10**

- LED light head can be swivelled 180° and 270°
- High-performance LED cordless light with 8 LEDs
- 3 brightness levels: 200 · 500 · 1000 lm

9500P-3/3

EAN-No. 4000896279883



## Cordless drill set, 18 V



**Contents**

- Cordless drill 9530-10
- 2x Li-ion battery packs 9500-025 (2.5 Ah, 18 V)
- Quick charger 9500-18



2.5 Ah, 18 V



**Cordless drill 9530-10**

- Number of torque levels: 18 + 1
- Drill chuck collet chuck: 1.5 – 13 mm
- Weight (without rechargeable battery): 1.14 kg



9530-1/4

EAN-No. 4000896265213



## Cordless drill, 1/2" cordless impact wrench, cordless right-angle grinder set, 18 V

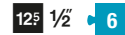

**Contents**

- Cordless drill 9530-10
- 1/2" Cordless impact wrench 9512-950
- Cordless right-angle grinder 9533-10
- 2x Li-ion battery packs 9500-05 (5 Ah, 18 V)
- Quick charger 9501-1018



**Cordless drill 9530-10**

- Number of torque levels: 18 + 1
- Drill chuck collet chuck: 1.5 – 13 mm
- Weight (without rechargeable battery): 1.14 kg

9500P-1/6

EAN-No. 4000896265190



1/2"



**1/2" Cordless impact wrench 9512-950**

- Max. loosening torque: 950 Nm
- Revolutions per minute: 2450
- Weight (without battery): 1.17 kg



5 Ah, 18 V



**Cordless right-angle grinder 9533-10**

- Revolutions per minute: 10000
- Maximum disc diameter: 125 mm
- Weight (without rechargeable battery): 1.8 kg

**Quick charger**

- Charger with "traffic light display": Shows state of charge in colour (red-yellow-green) and remaining time until fully charged



## Hybrid cordless radio, cordless dry vacuum cleaner, cordless work light set, 18 V

### Contents

- Professional hybrid cordless DAB radio 9580-10
- Cordless dry vacuum cleaner 9543-10
- Cordless work light 9579-10



3

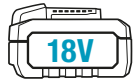

### Rechargeable battery 9543-10

- Filter area: 3000 cm<sup>2</sup>
- Container volume: 6 l
- Weight (without rechargeable battery): 3.3 kg

### Cordless work light 9579-10

- 1000 lm
- LED light head can be swivelled 180° and 270°

### Incl. 230 V power supply unit (ready for immediate use)

Without rechargeable battery and charger

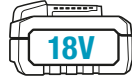

### Professional hybrid cordless radio with Bluetooth®, 18 V and 230 V 9580-10

- Bluetooth®, Aux input, USB port, charging option for smartphones, tablets
- DAB and FM
- 2x 10 W
- Weight (without rechargeable battery): 4.3 kg



9500P-2/3

EAN-No. 4000896265152



## 1/2" Cordless impact wrench, compact, 18 V max. loosening torque: 600 Nm

- **Auto stop function stops the machine as soon as the striking mechanism starts or stops working when it is released: Avoids overtightening or loss of screws and nuts during operation**
- Select auto stop function via the "M" button
- Short head length and compact design ensure ideal working in tight installation spaces
- 5-stage synchronised integrated LED light
- Prevents overtightening e.g. of small screws thanks to the option of setting in three different speed ranges ("Speed Command")
- Forward / reverse with switch-on lock
- Max. tightening torque: 406 Nm
- Loosening torque maximum: 600 Nm
- Idle speed · level 1: 0–1000 rpm
- Idle speed · level 2: 0–1800 rpm
- Idle speed · level 3: 0–2700 rpm
- Idle stroke rate: 0–3750 rpm
- Electronic emergency brake
- Ergonomically designed, non-slip rubberised handle
- LED battery capacity indicator on the battery pack
- Compatible with all 18 V battery packs in the 9500 series
- Weight (without battery): 1.2 kg

1/2"



12 1/2

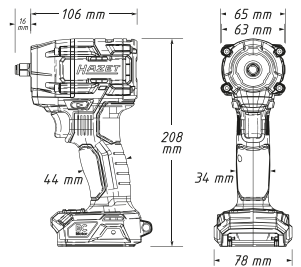
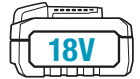

Without rechargeable battery and charger

9512-600

EAN-No. 4000896265053



**Wood function:** significantly increases performance when driving screws into wood.

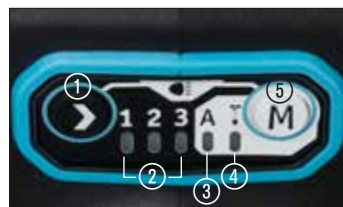

- |   |                                                 |
|---|-------------------------------------------------|
| ① | Selection button for levels 1 - 3               |
| ② | Status lights: levels 1 - 3                     |
| ③ | Indicator lights: Auto stop function            |
| ④ | Indicator light: Wood function                  |
| ⑤ | Selection button for auto stop or wood function |



**Auto stop function** stops the machine as soon as the striking mechanism starts or stops working when it is released:  
Avoids overtightening or loss of screws and nuts during operation!

## 1/2" Cordless impact wrench, 18 V Max. loosening torque: 950 Nm

125 1/2"

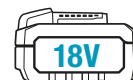

- **Auto stop function stops the machine as soon as the striking mechanism starts or stops working when it is released: Avoids overtightening or loss of screws and nuts during operation**
- Select auto stop function via the "A" button
- Powerful striking mechanism for maximum power enables the operation of stuck, e.g. rusted screw connections, even in extreme applications
- LED light with persistence afterglow
- Prevents overtightening e.g. of small screws thanks to the option of setting in three different speed ranges ("Speed Command")
- Forward / reverse with switch-on lock
- Tightening torque · level 1: maximum: 150 Nm
- Tightening torque · level 2: maximum: 200 Nm
- Tightening torque · level 3: maximum: 750 Nm
- Loosening torque maximum: 950 Nm
- Idle speed · level 1: 0–1000 rpm
- Idle speed · level 2: 0–2000 rpm
- Idle speed · level 3: 0–2450 rpm
- Electronic emergency brake
- Machine head made of die-cast aluminium in a compact design
- Shock-resistant and extremely durable
- LED battery capacity indicator on the battery pack
- Compatible with all 18 V battery packs in the 9500 series
- Weight (without battery): 1.9 kg

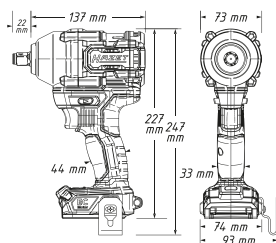

Patented vibration damping protects the wrist and the battery locking element



- |   |                                         |
|---|-----------------------------------------|
| ① | Selection button for levels 1 - 3       |
| ② | Status lights: levels 1 - 3             |
| ③ | Indicator light: Auto stop function     |
| ④ | Selection button for Auto Stop function |



Without rechargeable battery and charger

9512-950  
EAN-No. 4000896265039



## 3/4" Cordless impact wrench, 18 V Max. loosening torque: 2100 Nm

20 3/4"

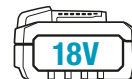

- **Auto stop function stops the machine as soon as the striking mechanism starts or stops working when it is released: Avoids overtightening or loss of screws and nuts during operation**
- Select auto stop function via the "M" button
- Integrated LED light can be set to five different levels
- Prevents overtightening e.g. of small screws thanks to the option of setting in three different speed ranges ("Speed Command")
- Forward / reverse with switch-on lock
- Infinite speed regulation
- Number of torque levels: 3
- Idle speed gear · level 1: maximum 500 rpm.
- Idle speed gear · level 2: maximum 1000 rpm.
- Idle speed gear · level 3: maximum 1900 rpm.
- Loosening torque maximum: 2100 Nm
- Idle stroke rate: 0–2350 rpm
- Electronic emergency brake
- Ergonomically designed, non-slip rubberised handle
- Machine head made of die-cast aluminium in a compact design
- Shock-resistant and extremely durable
- LED battery capacity indicator on the battery pack
- Compatible with all 18 V battery packs in the 9500 series
- Weight (without battery): 3.1 kg

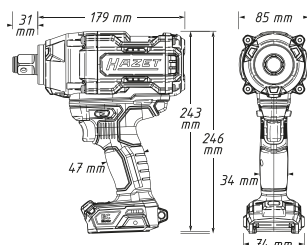

Patented vibration damping protects the wrist and the battery locking element



- |   |                                         |
|---|-----------------------------------------|
| ① | Selection button for levels 1 - 3       |
| ② | Status lights: levels 1 - 3             |
| ③ | Indicator light: Auto stop function     |
| ④ | Selection button for Auto Stop function |



Without rechargeable battery and charger

9513-2100  
EAN-No. 4000896265015



## Cordless drill, 18 V

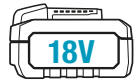

- Compact, powerful drill with extremely short head length
- Quick-action drill chuck, metal version with auto-lock function
- Electronic emergency brake
- Forward/reverse with switch-on lock
- Ergonomically designed, non-slip rubberised handle
- LED light with persistence afterglow
- Belt clip and drill bit storage
- Number of torque levels: 18 + 1
- Tightening torque (hard) maximum: 65 Nm
- Maximum drill diameter: 1.5 - 13 mm
- Idle speed gear · 1st gear: 0–500 rpm.
- Idle speed gear · 2st gear: 0–1800 rpm.
- LED battery capacity indicator on the battery pack
- Compatible with all 18 V battery packs in the 9500 series
- Weight (without rechargeable battery): 1.14 kg

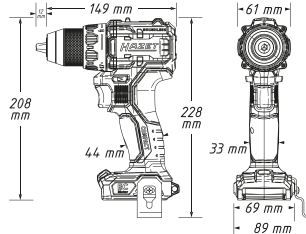

Without rechargeable battery and charger  
**9530-10**  
 EAN-No. 4000896266142

## Cordless impact drill, 18 V

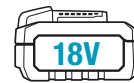

**NEW!**

- **Electronic Management System (EMS) protects the machine, extends service life and increases efficiency**
- **Anti-kickback switches off the motor when screw connections and drill holes are blocked, preventing the wrist from twisting**
- Turbo mode for faster and more powerful work. Switching on the turbo boost achieves up to 27 % higher speed
- Maximum torque of 158 Nm for drilling, impact drilling and screwdriving, even in extreme applications. The selected torque setting is retained when switching from the drilling to the impact drilling function thanks to direct switching
- Forward/reverse with switch-on lock
- Electronic emergency brake
- Robust die-cast aluminium gearbox housing
- Quick-action drill chuck in metal design with thrust ring and auto-lock function
- Ergonomically designed, non-slip, rubberised handle
- Integrated LED light with persistence afterglow
- LED rechargeable battery capacity indicator
- Bore diameter maximum
  - Wood: 89 mm
  - Steel: 13 mm
- Includes mountable auxiliary handle, belt clip and bit storage
- Sound pressure level: 93 dB(A) LpA
- Sound power level LWA: 104 dB(A)
- Uncertainty: K=3 dB (A)
- Vibration acceleration: 3.24 m/s<sup>2</sup>
- Uncertainty: K = 1.5m/s<sup>2</sup>
- Compatible with all 18 V battery packs in the 9500 series
- Weight (without rechargeable battery): 1.7 kg

**Maximum torque:  
158 Nm**

**With impact function!**

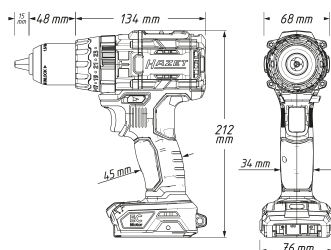

Without rechargeable battery and charger

**9530-11**

EAN-No. 4000896272730



## Cordless right-angle grinder, Ø 125 mm, 18 V

- Ergonomic, compact housing design
- Soft start thanks to microprocessor electronics
- Restart interlock after power failure
- Overload protection
- Temperature control
- Anti-kickback – device stops if the speed drops sharply due to canting
- Removable metal protective grille ensures dust protection
- Angled side handle offers ergonomic arm working position
- Softgrip inlays in the extremely slim grip area ensure a perfect feel
- Quick adjustment of protective cover without tools
- Incl. separation protective hood
- Spindle lock
- Spindle thread: M14
- Without battery · Without charger
- Battery voltage: 18 V
- Battery capacity: 5 Ah
- Disc diameter: 125 mm
- Revolutions per minute: 10.000
- LED battery capacity indicator on the battery pack
- Compatible with all 18 V battery packs in the 9500 series
- Dimensions (L x W x H): 295 x 75 x 120 mm
- Weight (without rechargeable battery): 1.6 kg

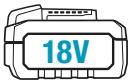

Incl. protective cover for separating cuts



HAZET No.	Spare parts		EAN-No. 4000896 +
9233-010/5	Cut-off wheel set (125 x 1 x 22.23 mm)	5	219063
9233-010/25	Cut-off wheel set (125 x 1 x 22.23 mm)	25	219070
9233-011/10	Rough grinding wheel set (125 x 6 x 22.23 mm)	10	219087



Without rechargeable battery and charger  
**9533-10**  
EAN-No. 4000896265091

## Cordless reciprocating saw, long stroke, 18 V

- Compact, powerful device with large stroke (25 mm)
- Bright dual LED light with persistence afterglow
- Tool-free quick-change saw blade system with ejection function ensures contact-free saw blade changes
- Double bearing-mounted lifting rod guide with vibration compensation ensures fatigue-free working
- Swivelling saw support adapts optimally to the workpiece
- Saw blade: 180° reversible
- Battery capacity: 5 Ah
- Overload protection
- Idle stroke rate: 0 – 3000 rpm
- Maximum material thickness wood: 210 mm
- Maximum material thickness aluminium: 30 mm
- Maximum material thickness metal tube: 110 mm
- LED battery capacity indicator on the battery pack
- Compatible with all 18 V battery packs in the 9500 series
- Dimensions (L x W x H): 358 x 78 x 159 mm
- Weight (without rechargeable battery): 1.9 kg

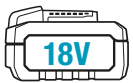

HAZET No.	5 flexible reciprocating saw blades each	Length of serration mm	EAN-No. 4000896 +
9234M-150/5	For steel and non-ferrous metal from 2 – 8 mm	130	239382
9234P-150/5	For wood with nails and faster sawing progress in metal 2 – 10 mm	130	239405
9234P-225/5	For wood with nails and faster sawing progress in metal 2 – 10 mm	205	239412
9234X-150/5	For steel and stainless steel (Inox) from 1.5 – 4 mm	130	239597
9234W-225/5	For all wood types, plastics as well as plasterboard 6 – 100 mm	205	239429
9034P-R/5	Reciprocating sabre saw blades	132	218318



Without rechargeable battery and charger  
**9534-10**  
EAN-No. 4000896265077



### Cordless work light, 1000 lm, 18 V

- LED light head can be swivelled 180° and 270°
- Lights up the work area perfectly
- High-performance LED cordless light with 8 LEDs
- 3 brightness levels: 200 · 500 · 1000 lm
- Colour temperature 4000 CCT
- Strong integrated magnets guarantee a secure and flexible hold
- Metal bracket for flexible positioning or for carrying the lamp
- Belt clip
- Ergonomic grip surfaces with soft grip
- Operating time with 2.5 Ah battery pack 4 hours, with 5 Ah battery pack 9.5 hours
- LED battery capacity indicator on the battery pack
- Compatible with all 18 V battery packs in the 9500 series
- Dimensions (L x W x H): 150 x 80 x 210 mm
- Weight (without rechargeable battery): 0.6 kg

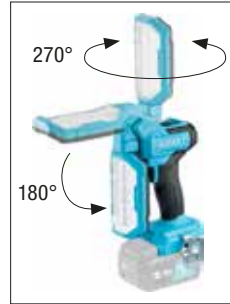

#### Super light!

Without rechargeable battery and charger  
**9579-10**  
 EAN-No. 4000896265275



### Cordless heat gun, 18 V

- Hot air blower with 2 temperature settings 260°/ 530° C and 2 air flow settings
- Heating (air flow) up to 300° C in ~ 15 seconds
- Ideal for a wide range of applications: Curing, drying and for stickers. Shaping and shrinking of plastic parts and shrink tubing
- LED light for lighting up the work area perfectly
- Lockable on / off switch
- Compact, ergonomic design
- Maximum air flow rate: 200 l/min
- Temperature levels: 2
- Air flow: 130 · 200 l/min
- Battery capacity: 5 Ah
- LED battery capacity indicator on the battery pack
- Compatible with all 18 V battery packs in the 9500 series
- Dimensions (L x W x H): 172 x 74 x 214 mm
- Weight (without rechargeable battery): 0.6 kg



Including flat, reflector and reducing nozzle for numerous applications

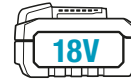

Without rechargeable battery and charger  
**9590-10**  
 EAN-No. 4000896265299



### Hybrid fan, 18 V and 230 V

- Infinite air volume regulation
- Soft start
- Flexible in use thanks to hook, 1/4" and 5/8" mount and 180° swivelling head
- Operation with 18 V battery or via 230 V power supply unit
- Threads for construction and photo tripods on the underside (fixing points on the underside)
- Running time at maximum speed: approx. 2.2 hours with battery pack 2.5 Ah and approx. 4.5 hours with battery pack 5 Ah
- LED battery capacity indicator on the battery pack
- Battery capacity: 2.5 Ah · 5 Ah
- Air flow: 18.25 m³/min
- Sound pressure level according to EN 60745: 70 dB (A)
- Compatible with all 18 V battery packs in the 9500 series
- Dimensions (L x W x H): 213 x 304 x 400 mm
- Weight (without rechargeable battery): 2.5 kg

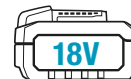

#### Hybrid function 18 V and 230 V

Without rechargeable battery and charger  
**9544-10**  
 EAN-No. 4000896264995



## Professional hybrid cordless radio with Bluetooth, 18 V and 230 V



- Robust radio for DAB+ and FM reception
- Speaker output 2 x 10 W and bass boost for top sound quality
- Illuminated LCD display · Coloured LED light strip · Digital clock · Retractable, flexible antenna
- Bluetooth® · Aux input · USB port · Charging option for smartphones, tablets
- Automatic station search and 5 programme presets
- Mute function
- Battery voltage: 18 V
- Battery capacity: 2.5 · 5 Ah
- DAB+ frequencies: 174.928 – 239.200 MHz
- FM frequencies: 87.5 – 108 MHz
- Protection rating: IP64
- LED battery capacity indicator on the battery pack
- Compatible with all 18 V battery packs of the 9500 series
- Dimensions (L x W x H): 369 x 212 x 201 mm
- Weight (without rechargeable battery): 4.3 kg



**Hybrid function  
18 V or 230 V**

Incl. 230 V mains adapter (ready for immediate use) without battery and charger

**9580-10**  
EAN-No. 4000896264971



## Cordless dry vacuum cleaner, 18 V

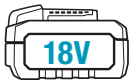

- High-performance turbine ensures high suction power and high underpressure: This produces an excellent suction result
- By activating the manual filter cleaning function, the filter element is freed from deposited dust by a targeted blast of air
- Optimised cleaning and increased filling level of the container thanks to flat pleat filter
- Accessories storage thanks to integrated holders on the suction head
- Compact hose  $\varnothing$  32 mm, extendable from 0.5 m to 2.5 m
- Very handy for easy transport
- Dust class L
- Easy-to-fit chassis available as an accessory
- Eco mode, extends the battery life to up to 30 minutes at a maximum negative pressure of 12,000 Pa
- Operating time with battery pack 5 Ah 15 mins with max. output
- Battery voltage: 18 V
- Battery capacity: 5 Ah
- Maximum underpressure: 12000 Pa
- Filter area: 3000 cm<sup>2</sup>
- Container volume: 6 l
- Without suction control
- Hose length: 2.5 m
- Number of suction motors: 1
- LED battery capacity indicator on the battery pack
- Compatible with all 18 V battery packs in the 9500 series
- Dimensions (L x W x H): 240 x 200 x 400 mm
- Weight (without rechargeable battery): 3.3 kg



**With carrying strap for mobile use!**

Without rechargeable battery and charger

**9543-10**  
EAN-No. 4000896264957



## Accessories for cordless (9543-10) and corded (9643-10) dry vacuum cleaners

7

5

### Cleaning set

- For hard and soft floor coverings
- Cleaning set for vacuum cleaners 9543-10 and 9643-10

### Contents:

- Suction hose inner  $\varnothing$  32 mm x 1.5 m with bayonet connection
- Support sleeve clip with secondary air control
- Quick release ring clip red
- 3 x 360 mm plastic extension tube
- Hand pipe
- Combination nozzle with brushes and rubber strip



**9543-04/7**  
EAN-No. 4000896270989

### Fleece filter bag set

- Fleece filter bags offer high tear resistance and prevent a reduction in suction power when filled to high levels
- Fleece filter bags for our 9543-10 and 9643-10 vacuum cleaners
- Durable fleece filter bags belonging to dust class L



**9543-01/5**  
EAN-No. 4000896270965



## Right-angle grinder Ø 125 mm

- Soft start thanks to microprocessor electronics
- Restart interlock after power failure
- Anti-kickback – device stops if the speed drops sharply due to canting
- Removable metal protective grille ensures dust protection
- Ergonomic arm working position thanks to slanted side handle
- Auxiliary handle
- Quick adjustment of protective cover without tools
- Spindle lock
- Spindle thread: M14
- Disc diameter: 125 mm
- Voltage: 230 Volt
- Power consumption: 1100 W
- Power output: 680 W
- Frequency: 50/60 Hz
- Cable length: 4 m
- Revolutions per minute: 12000
- Vibration acceleration: 7.8 m/s<sup>2</sup> (uncertainty: K = 1.5 m/s<sup>2</sup>)
- Sound pressure level LPA: 90 dB (A)
- Sound power level LWA: 110 dB (A) (uncertainty: K = 3 dB)
- Dimensions (L x W x H): 275 x 75 x 105 mm
- Weight: 2 kg



Lockable slide switch



HAZET No.	Spare parts	▣	EAN-No. 4000896+
9233-010/5	Cut-off wheel set (125 x 1 x 22.23 mm)	5	219063
9233-010/25	Cut-off wheel set (125 x 1 x 22.23 mm)	25	219070
9233-011/10	Rough grinding wheel set (125 x 6 x 22.23 mm)	10	219087



9633-10  
EAN-No. 4000896264919

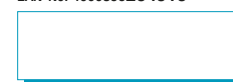

## Dry vacuum cleaner with chassis

- High-performance turbine ensures high suction power and high underpressure: This produces excellent suction results
- By activating the manual filter cleaning function, the filter element is freed from deposited dust by a targeted blast of air
- Optimised cleaning and increased filling level of the container thanks to flat pleat filter
- Accessories storage thanks to integrated holders on the suction head
- Compact hose Ø 32 mm, extendable from 0.5 m to 2.5 m
- Very handy for easy transport
- Dust class L
- Voltage: 230 V
- Power consumption 1200 W
- Maximum underpressure: 23000 Pa
- Filter area: 3000 cm<sup>2</sup>
- Container volume: 6 l
- Cable length: 5 m
- Hose length: 2.5 m
- Number of suction motors: 1
- Dimensions (L x W x H): 300 x 230 x 440 mm
- Weight: 4.7 kg



Incl. chassis (9543-03)



9643-10  
EAN-No. 4000896264933



### Flat pleated filter

- Dirt-repelling surface and long service life
- Flat pleated filter for our 9543-10 and 9643-10 vacuum cleaners
- Flat pleated paper filter of dust class L



9543-02  
EAN-No. 4000896270941



### Chassis

- Easy to install
- Chassis for our 9543-10 and 9643-10 vacuum cleaners
- Equipped with four plastic castors, of which two are swivel castors



9543-03  
EAN-No. 4000896270927





## VIDEO BORESCOPIES WITH HD CAMERA – OPTIMAL DETAIL ACCURACY!

- ▶ Bright and sharper image
- ▶ Better details
- ▶ Clearer image



### HD video borescope set with 360° swivelling probe Ø 3.9 mm

- Corded connection of a smartphone as a display (Lightning / USB-C)
- Additional magnification of the image possible using the smartphone display (drag)
- Image memory dependent on smartphone memory
- Robust, swivelling and adjustable smartphone holder (span: 58 – 100 mm)
- With temperature warning alarm (app) and automatic switch-off if the maximum permissible camera temperature is exceeded
- Photo and video recording via app or control via operating elements of the borescope
- Joystick control of the camera probe on the basic unit
- Focus range (DOF): 5 – 100 mm
- Viewing angle (FOV): 100°

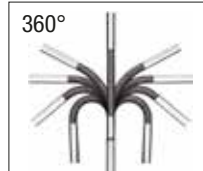

5



Detailed information



Your own smartphone as a display!

Removable Li-ion battery (1 x type 18650) without additional tools

Fully articulating probe with Ø 3.9 mm

#### 5-piece set in protective soft case with moulded insert:

- Basic unit and HD probe
- Data cable USB-A to Lightning (iOS), length: 0.3 m
- Data cable USB-A to USB-C (Android, current iOS etc.), length: 0.3 m
- Data cable USB-A to Micro-USB (Android etc.), length: 0.3 m
- Charging cable USB-A to USB-C, length: 1.0 m

Your own smartphone as a display



Joystick control



Smartphone holder (58 – 100 mm)



4812-24/4AF  
EAN-No. 4000896264568

## Thermal camera with fusion mode

- Screen size: 2.4 inch LCD screen
- Display resolution: 320 x 240 pixels
- Thermal (or Enhanced IR) resolution: 160 x 120 pixels
- Field of view: 50° x 50°
- Temperature measuring range: -20°C to 550°C
- Battery life: up to 8 h
- Integrated 4 GB flash memory (up to 18,000 images)
- Dimensions (H x W x D): 196 x 117 x 59 mm
- Weight: 290 g



Photo + thermal object image = Fusion Mode



Laser pointer for targeting

Additional camera for creating visual images enables Fusion Mode (640 x 480 pixels)

6 colour palettes for diagnostics

Field of view: 50° x 50°



Detailed information



1992N-1  
EAN-No. 4000896263523



**SAFE AND COMFORTABLE**

- ▶ It's all about safety, comfort and efficiency in the workplace
- ▶ Always up to date

**Mechanic's creeper**

- High capacity up to 150 kg (lying or sitting)
- 6 castors (∅ 63 mm)
- Combines creeper and seat
- Quick and easy switch between both functions
- Cushioned lying surface, head part in HAZET blue
- Dimensions (L x W x H): lying position 1198 x 440 x 135 mm, seat height 420 mm, seat surface 300 x 310 mm



**Sturdy steel tube frame with 2.4 mm material thickness**

**195N-3**  
EAN-No. 4000896256761

**Mechanic's creeper XXL**

- Prevents direct contact with dirt, oil or cold on the workshop floor, increases safety and hygiene in the workshop
- Integrated armrest for relaxed working
- High-quality HAZET logo screen print
- Ergonomic and compact design
- Dimensions (L x W x H): 1020 x 495 x 140 mm



**Comfortable working on and underneath a vehicle**

**480 mm extra wide lying surface**

**195XXL-2**  
EAN-No. 4000896275991

**Mechanic's creeper**

- High capacity up to 150 kg
- Ergonomically shaped: cut out arm areas for optimal elbow room
- 6 castors (∅ 70 mm)
- Practical storage compartments for tools and small parts on the right and the left
- Very comfortable: Soft upholstered head rest, HAZET blue
- Dimensions (L x W x H): 1030 x 480 x 115 mm



**Especially deep for maximum freedom of movement and comfort when working under the vehicle!**

**195N-2**  
EAN-No. 4000896252169

**Pneumatic chair**

- 5 low-noise, smooth-running castors with multiple bearings ∅ 75 mm
- Large, extra thick cushion ∅ 350 mm
- Easy to clean
- Capacity: dynamic capacity up to 150 kg
- Can be adjusted in height by hand: 430 – 550 mm
- Tool storage with practically divided compartments
- Provides a comfortable seat at the work area
- Pneumatically adjustable in height
- Tilt-resistant

**Particularly stable design thanks to square tubular frame**

**195N-4**  
EAN-No. 4000896261949



**Mechanic's mat**

- 975 x 385 x 30 mm

**195-5**  
EAN-No. 4000896153718



**Kneeling mat**

- 450 x 210 x 30 mm

**195-1**  
EAN-No. 4000896121069





## WE BRING LIGHT INTO THE DARKNESS

► We are constantly developing our product portfolio: This is how we provide you with the best possible support for your work and your projects!

### LED penlight, focusable

- Highly efficient light output of up to **500 lumens** - Light range of up to 100 metres
- 3 levels of brightness: 20%/50%/100% (regulated via on/off switch)
- Optimal illumination of dark work areas in industry, workshops, for hobbies or at home
- Aluminium housing (black anodised) stops dust and splash water entering the internal parts (IP44)
- With high-quality pen clip
- Number of rechargeable batteries/batteries: Dual Power: can be operated with a 3.7 V - 750 mAh Li-Ion rechargeable battery (included in the scope of delivery) or 2 AAA alkaline batteries LR03, 1.5 V (not included in the scope of delivery)
- Charging indicator: Red during the charging process, green when fully charged
- Weight: 61 g (including Li-Ion rechargeable battery)
- On/off switch can be easily operated even when wearing gloves
- LED technology: XPG4
- Protection rating (IP): IP44
- Protection rating (IK): IK08
- Length: 158 mm
- Diameter: 18 mm

**Choice of rechargeable battery or standard battery!**

Incl. USB-C charging cable, 50 cm



**NEW!**



Extendable head for switching between flood and focus light



Rotatable charging port cover



Technical data for rechargeable battery use (charging time 2.5 hours):

Mode	Lumen lm	Rechargeable battery runtime h	Range of light m
100 %	500	2	100
50 %	350	3	90
20 %	100	5,5	35



1979-74  
EAN-No. 4000896272853

### UV LED torch light

- Highly efficient light output of up to **800 lumens** - Light range of up to 150 metres
- Swivelling head (90°) for different light angles
- Optimal illumination of dark work areas in industry, workshops, for hobbies or at home
- 2 brightness levels: 50%/100%/ UV (long button press for UV light)
- Aluminium housing (black anodised) stops dust and splash water entering the internal parts (IP44)
- 2-in-1 button for charging and status display:
  - Charging display:
    - Solid green (fully charged)
    - Flashing green (charging in progress)
  - Status display:
    - Solid blue (battery capacity OK)
    - Flashing blue (approx. 10% battery capacity)
- With high-quality pen clip
- Strong holding magnet
- Rechargeable batteries: 3.7 V - 2600 mAh Li-Ion battery (included in the scope of delivery)
- Power supply: Rechargeable battery
- Weight: 165 g (including Li-Ion rechargeable battery)
- LED technology: XPG4 + 395 nm UV
- Protection rating (IP): IP44
- Protection rating (IK): IK08
- Length: 146 mm
- Diameter: 30.5 mm

Incl. USB-C charging cable, 50 cm



**NEW!**



2-in-1 button for charging and status display

Rotatable charging port cover



UV light for faster and clearer localisation of leaks



**Rotatable head!**

Technical data for use with rechargeable battery (charging time 4.5 hours):

Mode	Lumen lm	Rechargeable battery runtime h	Range of light m
100%	800	3	150
50%	475	7	99
UV	395	3	10



1979-75  
EAN-No. 4000896272891

Wireless charging light sets

LED light set

- Efficient and comfortable charging function due to optimised self-positioning of the light on the pad
- Wirelessly mobile and versatile, especially in extremely tight spaces

Contents:

- 1 x 1979W-11 pen light
- 1 x 1979W-85 solid light
- 1979WP-2 charging pad for 2 lights
- Incl. 100 cm USB-C cable and 2 A / 5 V power supply unit



1979W2/3

EAN-No. 4000896258208



Contents:

- 1979W-82 LED pocket light
- 1979W-92 LED slim light
- 1979WP-2 charging pad for 2 lights
- Incl. 100 cm USB-C cable and 2 A / 5 V power supply unit



1979W1/3

EAN-No. 4000896241408



Pressure sprayer

- Spraying with cleaning agents and disinfectants as well as for degreasing and lubrication
- Net volume: 1 l



199N-1

EAN-No. 4000896189007



Brush oiler

- Application of an even lubricating film to workpieces, surfaces and chains. Tool-friendly distribution of coolants and lubricants while drilling
- Replaceable brush  $\varnothing$  20 mm
- Semi-transparent container (PEHD) for better visibility of the filling level
- 20 bar pumping station
- Suspension lug
- Filling capacity: 0.3 l



2160-1

EAN-No. 4000896234646



Grease gun

- Actuation with ring-shaped push rod handle
- Reinforced hose, nozzle pipe and 2 mouthpieces M10 x 1
- Filling with grease cartridge, loose grease or via a grease filler
- Pre-greased boot
- Long operating lever for low effort and minimisation of the crushing risk
- Short stroke system
- Fill volume: 500 cm<sup>3</sup>



2162-1

EAN-No. 4000896075027



Magnetic cup

- $\varnothing$  150 mm



197-3

EAN-No. 4000896158584



Magnetic holder

- Magnetic pull-off force: axial maximum 18 kg



197-10

EAN-No. 4000896254392



Magnetic pick-up tool

- Permanent magnet
- Flexible shank
- For easily picking up metal objects from installation spaces that are difficult to access
- Special design prevents unwanted rolling away
- Hanging hole in the handle keeps the workshop tidy

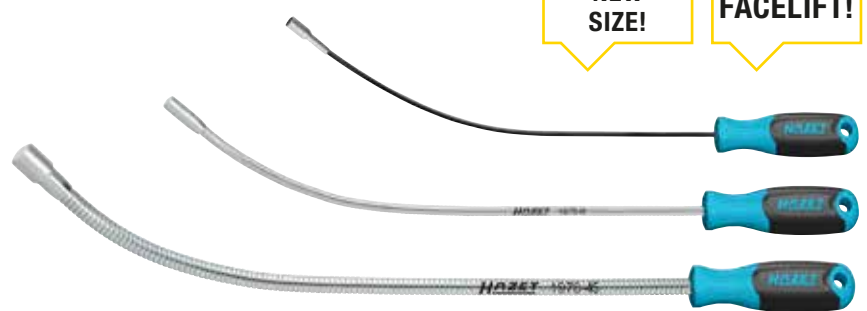

NEW SIZE!

FACELIFT!

HAZET No.	$\varnothing$ mm	Length mm	EAN-No. 4000896 +
1976N-3	3	300	279180
1976-11	8	470	273508
1976-45	15	515	273485



Two-coloured handle = three plastics:

1. Hardened core holds the lance extra-firmly in position
2. Soft component ensures very good grip even under difficult working conditions and with lubricating surfaces (oils, greases)
3. Hard component (very robust) gives the perfect shape, stability and a premium feel with every search operation

Multifunctional drain pans

- Filling capacity: 6 l



197N-1

EAN-No. 4000896198924



- Filling capacity: 16 l



197-2

EAN-No. 4000896146802



- Filling capacity: 50 l

Made in Germany

197-50

EAN-No. 4000896210008



# EASY. FAST. VERSATILE!

**NEW!**



Quick and easy changing of insert tools thanks to new locking system



No additional safety device is required due to the locking ball



Can be combined with more than 1,000 sockets

**New locking system in the power adapter, quick coupler 1003S-2**



**Unique with quick-release fastener!**



Surface: Burnished / chrome-plated

**Germany Made in Germany**

## 3/4" Power adapter, quick coupler

- Output: 24 mm hexagon socket
- Length: 54 mm
- For impact operation

Germany Made in Germany

**1003S-2**

EAN-No. 4000896273584



## Impact adapter, quick coupler set

- Interchangeable insertion blade ● 24 mm -
  - 1/2" drive
  - 3/4" drive
  - 1" drive



**Contents:**

- 1003S-2
- 1003S-07K (1/2")
- 1003S-08K (3/4")
- 1003S-09K (1")

Germany Made in Germany

**1003S/4**

EAN-No. 4000896273904



## 3/4" Power adapter on 1/2"

- Replaceable plug-in blades ● 24 mm -
  - drive = 1/2"



**Contents:**

- 1003S-2
- 1003S-07K (1/2")
- 1000S-G1736, o-ring
- 1000S-H1736, pin

Germany Made in Germany

**1003S-7/4**

EAN-No. 4000896280971



# 2-IN-1 SYSTEM!

**NEW!**



**1 socket  
2 drive options**

## 1/2" Impact socket set

40

## 1/2" · 3/4" Impact socket set

24

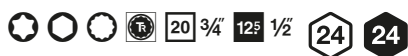

**NEW!**

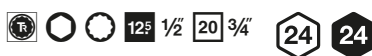

**NEW!**

2/3+			
------	--	--	--



Assortment



Incl.

Made in Germany  
163-612/40  
EAN-No. 4000896264704

1/3+			
------	--	--	--



Assortment



Incl.

Made in Germany  
163-570/24  
EAN-No. 4000896233441



Made in Germany

	HAZET No.	Designation	Incl. adapter 1003S-2		EAN-No. 4000896 +
①	900SZ6/11	1/2" · 3/4" 12-point traction profile set	✓	11	225378
②	990S/11	1/2" · 3/4" Impact XZN profile set	✓	11	162406
③	985S/11	1/2" · 3/4" Impact hexagon profile set	✓	11	211951
④	2784-T60/4	3/4" Brake disc screwdriver socket set	✓	4	188611
⑤	985S-22	1/2" Supplement to 985S/11	-	-	218219
⑥	985S-24	1/2" Supplement to 985S/11	-	-	218226
⑦	900SLg6-24	1/2" Impact socket	-	-	232789
⑧	990S-12/2	1/2" · 24 mm external hexagon impact screwdriver socket set, Internal multi-tooth XZN	-	2	264667
⑨	995S/6	1/2" · 24 mm impact screwdriver socket set, internal TORX®	-	6	264780
⑩	903SLg6/3	1/2" · 24 mm outside hexagon traction profile, impact socket set	-	3	264643



## 1/2" · 3/4" Impact universal joint sockets

- Hinge with 25° angular movement for use in spaces with restricted access and for getting around obstructive edges
- Short, space-saving design suitable for impact wrenches
- Particularly suitable for automotive applications, where space is limited, for chassis and brake repair, and in the engine compartment
- For industry or passenger car, commercial vehicle and agricultural workshops
- With traction profile
- Surface: burnished, oiled
- DIN 3121



125 1/2 20 3/4

All three 1/9 inserts result in a 1/3 insert:



Ideal for work on cardan shafts, chassis and fifth wheel plate/frame

**Made in Germany**

## 1/2" Impact universal joint socket set

- With borehole for locking pin or safety spring and groove for o-ring

• s 13 · 14 · 15 · 16 mm

4

Contents:

- 900SG-13
- 900SG-14
- 900SG-15
- 900SG-16



• s 17 · 18 · 19 · 21 mm

4

Contents:

- 900SG-17
- 900SG-18
- 900SG-19
- 900SG-21



**Made in Germany**

900SG-1316/4

EAN-No. 4000896272778



**Made in Germany**

900SG-1721/4

EAN-No. 4000896272792



**NEW!**

1/9			
-----	--	--	--



HAZET No.		S mm	l mm	d <sub>1</sub> mm	d <sub>2</sub> mm	t mm	EAN-No. 4000896 +
900SG-13	125 1/2	13	61,5	21	30	7,6	271863
900SG-14	125 1/2	14	61,5	22,3	30	8,5	271887
900SG-15	125 1/2	15	63	23,5	30	8,5	271900
900SG-16	125 1/2	16	63	24,8	30	8,5	271924
900SG-17	125 1/2	17	63	26	30	9	271948
900SG-18	125 1/2	18	63	27,3	30	10	271962
900SG-19	125 1/2	19	64,3	28,5	30	10	272006
900SG-21	125 1/2	21	65,7	31,5	30	10	271986

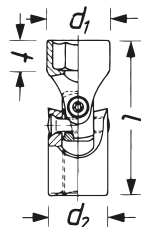

## 3/4" Impact universal joint socket set

- Particularly suitable for chassis and brake repairs in the commercial vehicle sector where space is limited. Used with BPW and SAF systems, especially in the special construction/special axes sector
- With borehole for locking pin and groove for O-ring
- s 22 mm and s 24 mm

Contents:

- 1000SG-22
- 1000SG-24



**NEW!**

2

1/9			
-----	--	--	--

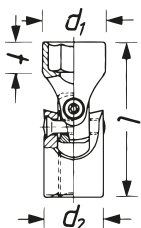

HAZET No.		S mm	l mm	d <sub>1</sub> mm	d <sub>2</sub> mm	t mm	EAN-No. 4000896 +
1000SG-22	20 3/4	22	90	37	44	11	271627
1000SG-24	20 3/4	24	90	35	44	12	271641

**Made in Germany**

1000SG-2224/2

EAN-No. 4000896272815

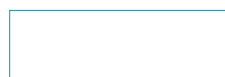



**COMPACT POWER**

- ▶ Developed for maximum power transmission in the smallest of spaces: The 1/2" HAZET impact socket set will accompany you safely through your everyday workshop life!

**1/2" Impact socket set**

- Particularly suitable together with short 1/2" impact wrenches e.g. HAZET 9012ATT, HAZET 9012PTT
- With borehole for locking pin or safety spring and groove for o-ring
- Surface: phosphatized, oiled
- DIN 3129, ISO 2725-2
- For impact operation
- Length (total): 29 mm
- **Content:** s 13, 14, 15, 16, 17, 18, 19, 21, 22, 24 mm

12<sup>5</sup> 1/2" 10

1/9			
-----	--	--	--

**Extra short design!**



**Made in Germany**  
**900SK/10**  
 EAN-No. 4000896246434



**3/4" Impact socket**

20 3/4"

**1" Impact socket**

25 1"

**Long design!**

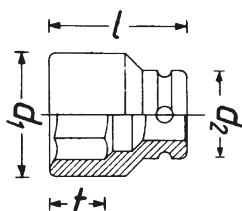

**Made in Germany**

HAZET No.	S mm	l mm	d <sub>1</sub> mm	d <sub>2</sub> mm	f mm	EAN-No. 4000896 +
1000SLG-24	24	100	39,5	44	17	001392
1000SLG-27	27	100	43,5	44	19	001408
1000SLG-30	30	100	47,5	44	21	001422
1000SLG-32	32	100	50	44	21	001439
1000SLG-33	33	100	51,5	44	21	001446
1000SLG-36	36	100	55	44	23	001460

**Made in Germany**

HAZET No.	S mm	l mm	d <sub>1</sub> mm	d <sub>2</sub> mm	f mm	EAN-No. 4000896 +
1100SLG-24	24	110	41,5	54	17	002405
1100SLG-27	27	110	45	54	19	002412
1100SLG-30	30	110	49	54	21	002429
1100SLG-32	32	110	51,5	54	21	002436
1100SLG-33	33	110	52,5	54	21	002443
1100SLG-36	36	110	56,5	54	23	002467
1100SLG-38	38	110	59	54	24	002474
1100SLG-41	41	110	63	54	26	002481
1100SLG-46	46	110	69,5	54	28	002498



## ONE CASE. MANY SOLUTIONS.

- ▶ The HAZET radiator adapter case gives you maximum flexibility for work on the cooling system - quickly to hand and perfectly organised.

### Commercial vehicle radiator adapter case

- Checking for leakage in cooling systems and heating circuits
- 4800-1 Cooling pump to 2.5 bar
- 4800-2 Intermediary piece, flexible hose
- 4800-3 Radiator adapter for **DAF** 45 model year 05/1991 → 12/2000 **DOOSAN** wheel excavator S, caterpillar excavator DX  
**KAESER** Mobilair  
**LIEBHERR** A308-316  
**MERCEDES-BENZ** Vito, Viano, Solaris  
**NISSAN** forklifts  
**PUTZMEISTER** BSA 1409  
**SCANIA**
- 4800-5A radiator adapter for **COMPAIR** mobile compressor with **VW** expansion tank  
**LINDE** forklift  
**PUTZMEISTER** BSA 1407D · BSA 2110 HP-D  
**RENAULT** Midlum model year 01/2000 → 12/2013  
**Volvo** FE model year 05/2006 → · FL model year 03/2000 →
- 4800-25 radiator adapter for **MAN** buses such as Lion's Coach, Lion's Star, Lion's Comfort, Lion's City  
**MERCEDES-BENZ** Citaro model year. 01/1998  
**IVECO** Euro-Star, Euro-Tech, Euro-Truck, Stralis, Daily with black lock  
**MAN** F90, F2000, TGA model year 03/2000 →, TGL model year 04/2005 →, TGM model year 10/2005 →, TGS model year 10/2007 → 01/2012, TGX model year 10/2007 → 01/2012  
**MERCEDES-BENZ** commercial vehicles Actros, Atego 1217 model year → 1999, Eco 8401, SK1728, Antos, Arocs, Atego model year 1998 → 2013, Axor model year 09/2001 → 10/2004, Econic, Zentros
- 4800-26 Radiator adapter for **DAF** CF, XF Euro 6 model year 2013 →
- 4800-27 Radiator adapter for **MERCEDES-BENZ** Atego model year 2014 →
- 4800-28 Radiator adapter for **MERCEDES-BENZ** Actros EURO 6 with HEYCO expansion tank model year 2014 →  
**MAN** TGX, TGS EURO 6 with HEYCO expansion tank model year 2012 →



Made in Germany

**4800/8**

EAN-No. 4000896216499

### Radiator tester for agricultural machinery

- Checking for leakage in cooling systems and heating circuits
- 4800-1 Cooling pump to 2.5 bar
- 4800-2 Intermediary piece, flexible hose
- 4800-3 Radiator adapter for **AMAZONE** Pantera  
**CLAAS** Jaguar · Lexion · Scorpion · Ares · Atlas · Ceres  
**FENDT**  
**MASSEY FERGUSON** with tank number 180224M92 and 4296015M1  
**CASE** Quadtrac · Magnum
- 4800-4 A Radiator adapter for **CASE** Puma · SBS · LBS · Optum · Maxxum · CVX  
**NEW HOLLAND** TVT · T7, T7 Elite Pack · T6  
**FENDT** Vario model year 2000 → Combine harvester L series  
**CLAAS** Arion · Axion  
**DEUTZ** engines 3.6 PowerPack · BF6M1013FC · TCD2013L6 2V and 4V genset 250KV
- 4800-5 A radiator adapter for **FENDT** Farmer 300 model year 1988 → · Type 500 · Type 700 · Vario model year 1988 → 2000
- 4800-20 radiator adapter for **CLAAS** Xerion · Tucano as well as all new **CLAAS** machines with **MERCEDES-BENZ** expansion tank



Made in Germany

**4800/6**

EAN-No. 4000896216482

### Commercial vehicle vacuum radiator filler

- Vacuum leakage test before filling the cooling system
- Suitable in conjunction with single or universal adapters, e.g. 4801-2/3
- New design of the vacuum radiator filler allows the desired vacuum to be reached faster, which allows the cooling system to be filled more quickly
- Fast coolant flow rate: 80 litres in approx. 20 minutes
- Filling with standard stoppers as well as with fixed cap
- No loss of coolant due to overflow of the cooling system
- Separate control through the diagnostic testing device is no longer necessary
- Hose: 10 x 16 mm
- Outside Ø: 16 mm
- Inside Ø: 10 mm



Made in Germany

**4802-1**

EAN-No. 4000896200030

**Filling of the coolant and heating circuit without bubbles in trucks · buses · agricultural machinery and construction vehicles**

## Cooling pump and adapter



Made in Germany

	HAZET No.	Components	EAN-No. 4000896+
①	4800-1	Cooling pump up to 2.5 bar	022243
②	4800-2	Intermediary piece, flexible hose	022274
③	4800-3	AMAZONE Pantera · CLAAS Jaguar, Lexion, Scorpion, Ares, Atlas, Ceres · DAF 45 model year 05/1991 → 12/2000 · DOOSAN wheel excavators S · Caterpillar excavators DX · FENDT · KAESER Mobilair · LIEBHERR A308-316 · MASSEY FERGUSON with container no. 180224M92 and 4296015M1 · MERCEDES-BENZ Vito · Viano · Solaris · NISSAN forklifts · PUTZMEISTER BSA 1409 · SCANIA Vabis · CASE Quadtrac, Magnum	022281
④	4800-4A	DEUTZ engines 3.6 PowerPack · BF6M1013FC · TCD2013L6 2V and 4V Genset 250kV · HATZ 4H50tic · IVECO Eco Daily with blue lock · CASE Puma, SBS, LBS, Optum, Maxxum, CVX · NEW HOLLAND TVT, T7, T7 Elite Pack, T6 · FENDT Vario model year 2000 → combine harvesters L-Series · CLAAS Arion, Axion	156504
⑤	4800-5A	COMPAIR Mobile compressor with VW expansion tank · FENDT Farmer 300 model year 1988 → Type 500 · Type 700 · Vario model year 1988 → 2000 · LINDE forklifts · PUTZMEISTER BSA 1407D · BSA 2110 HP-D · RENAULT Midium model year 01/2000 → 12/2013 · Volvo FE model year 05/2006 → FL model year 03/2000 →	161843
⑥	4800-16	DEUTZ engines KHD1015 · D2008 · D2009 · TD2.9 L4 · TCD3.6 · BFM1013 · BFM2012 · TCD2013 2V · BFM1015 · TCD2015 V8 · V6 · M · TCD 12.0 and 16.0 · MERCEDES-BENZ Sprinter model year 1999 → Type 170 · 208 · 611	098507
⑦	4800-17	JOHN DEERE tractors of Series 5, 6, 7, 8 and 9 · Forage harvesters of Series 8000 and 9000 · Self-propelled sprayer R4040, R4050, R4140 and 4150 · Windrower W170 · Cotton picker CP690 · Excavator 160DLC · Crawler dozer 700J · WHEEL LOADERS WL53, WL56 · HITACHI excavator ZAXIS 6 · HAGIE STS 10, 12, 14 and 16	109661
⑧	4800-18	MERCEDES-BENZ Sprinter since 2006, Viano since 2003	128815
⑨	4800-20	IVECO Euro-Star · Euro-Tech · Euro-Truck · Daily with black lock · MAN F90 · F2000 · TGA model year 03/2000 → TGL model year 04/2005 → TGM model year 10/2005 → TGS model year 10/2007 → 01.2012 · TGX model year 10/2007 → 01.2012 · MERCEDES-BENZ commercial vehicles Actros · Atego 1217 model year → 1999 · Eco 8401 · SK1728 Antos · Arocs · Atego model year 1998 → 2013 · Axor model year 09/2001 → 10/2004 · Econic · Zentros · CLAAS Xerion, Tucano	144242
⑩	4800-21A	Volvo commercial vehicles · Scraper tractor dumpers	162185
⑪	4800-23	ISUZU truck · MITSUBISHI commercial vehicle Fuso Canter · NISSAN forklifts · YALE GDP/GLP 16-30	144273
⑫	4800-25	MAN buses such as Lions Coach · Lions Star · Lions Comfort · Lions City · MERCEDES-BENZ Citaro model year 01/1998	203857
⑬	4800-26	DAF CF and XF Euro 6 from 2013	214495
⑭	4800-27	MERCEDES-BENZ Atego from model year 2014	214501
⑮	4800-28	MERCEDES-BENZ Actros EURO 6 with HEYCO expansion tank from model year 2014	214518
⑯	4800-29	SCANIA 143, G-/P- and R series	222780

## Manual decanting / filling pump

- 600 ml pump volume – bubble-free, fast transfer pumping and filling of fluids
- Base plate and double connection for hoses with 10–15 mm inside Ø
- 1 suction hose, Ø 10 mm · length: 3 m
- 1 pressure hose, Ø 15 mm · length: 3 m
- On e.g. MERCEDES-BENZ Citaro Euro 6 together with coolant pipe 2 x A.311.500.09.91 and coupling muff A.001.553.19.26 and coupler plug A.001.553.20.26
- Fluids to be pumped, e.g. AdBlue® - coolant - windscreen antifreeze - water - transmission or engine oils



Made in Germany

2162-7

EAN-No. 4000896207756

## Optical tester (refractometer)

- Measurement of the anti-freeze concentration in the coolant, also suitable for coolants G11, G12+, G12 EVO, G13, GG40, G48 and G64
- Checking the quality of the AdBlue® operating fluid, checking the battery acid density (state of charge of the battery)
- Optical tester (refractometer) with integrated lighting (LED) in the lid
- Including removal pipette and operating instructions



Made in Germany

4810C

EAN-No. 4000896186402

Scale description:

- A – state of charge
- B – AdBlue®-content
- C – anti-freeze concentration
- D – screenwash anti-freeze concentration
- 5 – light / dark line for reading the scale

## Flexible hose clamp set

- Clamping flexible hoses



4590/3

EAN-No. 4000896058266

HAZET No.	Length mm	Hose Ø mm	EAN-No. 4000896+
4590-1	150	15	021932
4590-2	180	30	021949
4590-3	253	60	055753



**WE TACKLE WHERE OTHERS SLIP!**

► We are continuously developing our HAZET oil filter wrenches and oil filter chain wrenches so that you can loosen any oil filter quickly, safely and without loss of power.

Oil service



**1/2" Oil filter chain wrench, open** 125 1/2"

- Opening of the oil filter chain wrench allows them to be used even in places which are almost completely out of reach due to the construction
- For the operation of air dryer cartridges

• Clamping range: 50 – 150 mm



**Made in Germany**  
**2171-8LG**  
 EAN-No. 4000896203703



**Oil filter wrench**

- Operation of oil filters e.g. as an assembly tool for oil and fuel filters on **MAN** commercial vehicles
- Steel strip adjustable to seven positions

• Clamping range: 80 – 110 mm



**Made in Germany**  
**2171-1**  
 EAN-No. 4000896013418



• Clamping range: 75 – 110 mm



**Made in Germany**  
**2171-2**  
 EAN-No. 4000896013432



**Cartridge wrench**

- Operating the granulates cartridge on commercial vehicles with compressed air dryers
- Forged design
- Design "Made by HAZET"
- Negative position of arms
- **MAN** 8099606-0307
- **Diameter: 90 – 140 mm**



**Made in Germany**  
**2195**  
 EAN-No. 4000896014101



**3/8" Oil filter wrench**

10 3/8"

- Installing and removing **oil filters and oil filter housing caps** when changing the oil filter element
- Forged design



**Made in Germany**

HAZET No.	Application for	EAN-No. 4000896 +
2169-32	For urea solution filter Ad-Blue® <b>MAN</b> e.g. TGX	082346
2169-36	E.g. for <b>MERCEDES-BENZ</b> engine 116 MB · 100 D Transporter · Actros MP 1 · MP 2 · For fuel filter <b>MAN</b> e.g. TGA	086566

**1/2" Oil filter wrench**

125 1/2" 24

- Operation of oil filters e.g. from **MANN** as well as **MAHLE / KNECHT**
- Für e.g.: **Volvo · SCANIA · RENAULT · MAN · IVECO · FIAT · FODEN · IRISBUS · ASTRA · CATERPILLAR · LIEBHERR · JOHN DEERE · KOMATSU · FAUN · MITSUBISHI**



**Made in Germany**  
**2169-9**  
 EAN-No. 4000896116690



## Injector sliding hammer, pneumatic

- Used for a wide range of products in the light van segment and for a lot of municipal vehicle applications.
- For removing stuck diesel injectors
- 21 different adapters and a universal claw can be used to gently loosen stuck diesel injectors without much effort. Depending on the injector version, the piezo element must be removed for this purpose
- This prevents damage to the cylinder head/cylinder head cover due to high forces from supports
- In plastic case

### Contents:

- Pneumatic diesel injector puller
- Extension for deep-seated injectors or obscured installation spaces
- Universal claw
- 21 adapters:
  - M8 x P1.0, M8 x P1.25, M10 x P1.0, M10 x P1.5, M14 x P1.0, M14 x P1.5 **DELPHI**,
  - M16 x P1.0 for **TOYOTA**,
  - M17 x P1.0 for **BOSCH** 110,
  - M18 x P 0.75 for **BOSCH** 120,
  - M18 x P1.5 Universal adapter,
  - M20 x P 1.0 for **DENSO/A**,
  - M25 x P0.5 for **DENSO**,
  - M25 x P1.0 for **BMW · BOSCH · FIAT · MERCEDES-BENZ · PSA · PSAW · RENAULT · SIEMENS**,
  - M26 x P0.75 for **BOSCH** CRIN 2
  - M27 x P0.75
  - 2 x M27 x P1.0 for complete thread for **SIEMENS**,
  - M29 x P1.0,
  - M31 x P0.75 for **BOSCH** CRIN 1,
  - Adapter with inside thread M12 x P 1.5 / outside thread M20 x P 1.5,
  - Adapter with inside thread M14 x P 1.5 / outside thread M22 x P1.5

Gentle and careful working!

24



9098/24

EAN-No. 4000896258086



## 3/8" AdBlue® filter wrench

10 3/8"

- Operation of the filter housing cap when changing the filter element for the AdBlue® filter (urea solution filter element) on **MERCEDES-BENZ** commercial vehicles with BlueTEC® engines e.g. Actros, Atego, Axor, Econic
- The tightening torque recommended by the vehicle manufacturer (please follow the instructions of the manufacturer) is reached e.g. with the torque wrench HAZET 6110-1CT



Made in Germany

2168-46

EAN-No. 4000896156252

## 1/2" Fuel filter wrench · grooved profile

125 1/2"

- Operation of fuel filter housing on construction and agricultural machinery
- For e.g.: **CLAAS** Torion, **LIEBHERR** wheel loaders and wheel loaders with Euro 6 emission standard and **LIEBHERR**, **JOHN DEERE** engines
- **HARVESTER** 1070G, 1170G · Forwarder 1110G, 1210G, 1510G · Caterpillar-track timber crane 2154G, 2154G · Log loader 2156G, 2156G LC · Timber crane, hitch-mounted 337E, 437E · Wheel loader 524K, 524K-II, 524L, 544K, 544L · Field sprayer, self-propelled R403, R4040L, R4050L · Tractors 6M, 6R series · Tractors 7R series · Combine T series · Combine W series · Bulldozer 700K · Excavator 210G LC Deere · Sprayer Mazzotti MAF HP · Hagie STS 10, STS 12

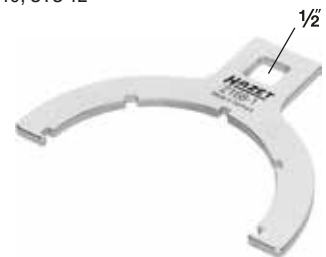

Made in Germany

2168-1

EAN-No. 4000896223251

## AdBlue® and fuel line pliers

- For use when replacing the fuel filter or performing repair work on the engine
- Simple operation of quick-release fasteners
- For e.g. **MERCEDES-BENZ** commercial vehicles
- **Volvo** D13 · D16 · **MAN** D3876 LF · D1556 LF · D2676 LF and **SCANIA** engines
- **CLAAS** agricultural machinery with **MAN** engine
- AdBlue® lines as well as AdBlue® injection nozzle
- Length: 235 mm



Made in Germany

4501-2

EAN-No. 4000896203499

## Turbo charger wrench · outside 12-point



- Operation of the turbo charger nuts on **MAN** commercial vehicles
- Bent form of the box-end wrench is especially adapted to the confined spaces
- Length: 266 mm



Made in Germany

2849-15

EAN-No. 4000896159284

## Exhaust probe sockets

- For removal and installation of the lambda probe, particle sensor, NOX sensor and exhaust gas temperature sensor
- Double square drive 12.5 = 1/2"
- Additional hexagon drive
- Also suitable for closing the slot to avoid widening the opened hexagon
- Torque-controlled tightening possible
- For manual operation
- Surface: phosphatized, oiled
- Dimensions: L 66 x H 39 mm
- Slot width: 8 mm



**Robust design for fixed exhaust probes!**



**Made in Germany**

HAZET No.	S mm	Application on e.g.	Double drive: 1/2" or	EAN-No. 4000896 +
4680-7	14	MERCEDES-BENZ · IVECO	Operation with hexagon drive s 24 mm	254118
4680-8	17	MERCEDES-BENZ · AUDI · PORSCHE · SEAT · ŠKODA · VW · FIAT · ALFA ROMEO · LANCIA · OPEL	Operation with hexagon drive s 24 mm	254132
4680-9	19	MERCEDES-BENZ · AUDI · PORSCHE · SEAT · ŠKODA	Operation with hexagon drive s 24 mm	254156
4680-10	20	IVECO Stralis, S-Way	Operation with hexagon drive s 24 mm	267026
4680-5	22	FORD · BMW · OPEL · VW · AUDI · SEAT · ŠKODA · MAN TGE	Operation with hexagon drive s 30 mm	057870
4680-6	24	OPEL · NISSAN · RENAULT · AUDI · VW · PORSCHE · MERCEDES-BENZ · MAN · GENERAL MOTORS · DODGE Ram · JEEP	Operation with hexagon drive s 30 mm	252268

## Special tap for exhaust gas temperature sensors / probes

- Professional repair, cleaning or repairing of the mounting threads of the exhaust gas temperature sensors / probes
- Guide bolt prevents jamming of the thread repair tool, thereby enabling exact repair or cleaning of the sooty or damaged thread
- Time saving: replacement of the exhaust system is no longer necessary in most cases
- No tilting or jamming during repair
- 6 cutting surfaces for optimal fitting accuracy as well as easy and quick handling
- High-quality TiAIN coating for longer service life
- Suitable for application on stainless steel components
- Drive: s 13 mm



**Made in Germany**

### Thread size: M12 x 1.25

- For exhaust gas temperature sensors on: SUZUKI · IVECO · RENAULT TRUCKS · Volvo TRUCKS
- Length: 55 mm

**4683-12**  
EAN-No. 4000896253555



### Thread size: M14 x 1.5

- For exhaust gas temperature sensors on: MERCEDES-BENZ
- Length: 45 mm

**4683-14**  
EAN-No. 4000896253579



### Thread size: M16 x 1.5

- For exhaust gas temperature sensors on: MERCEDES-BENZ Trucks, Bus & DAF commercial vehicles Actros · Axor · Atego · MB Bus O 500 BM382 · DAF CF 65 · DAF CF 75 · DAF CF 85 · DAF CF 105
- Length: 43 mm

**4683-16**  
EAN-No. 4000896253593



### Thread size: M18 x 1.5

- For lambda sensors on: MERCEDES-BENZ · Volvo TRUCKS
- Length: 42 mm

**4683-18**  
EAN-No. 4000896253616



### Thread size: M20 x 1.5

- For NOX sensors on: DAF · MERCEDES-BENZ TRUCKS · IVECO · MAN · SCANIA · RENAULT TRUCKS · Volvo TRUCKS
- Also suitable for passenger car models where a NOX sensor or particulate filter sensor with thread M20 x 1.5 is installed, e.g. BMW · AUDI · VW · OPEL/VAUXHALL · MERCEDES-BENZ
- Length: 50 mm

**4683-20**  
EAN-No. 4000896253630



### Thread size: M22 x 1.5

- For particle sensors on: MERCEDES-BENZ · MAN
- Length: 50 mm

**4683-22**  
EAN-No. 4000896253654



## Tool set for exhaust probes

### 10-piece set:

- Special taps: 4683-12, 4683-14, 4683-18, 4683-20, 4683-22
- Exhaust probe sockets: 4680-5, 4680-6, 4680-7, 4680-8, 4680-9

**Made in Germany**

**163-611/10**

EAN-No. 4000896257294



**For commercial vehicle applications!**

4683-16 Optionally available



**10**

Optionally available:  
Toolbox for safe storage



HAZET No.	EAN-No. 4000896 +
165-L	167777

### Injector claw

- For removal of fixed common rail injectors without removing the cylinder head
- Simple extraction of injectors
- Inside thread: M10 x 1.5 mm
- **MAN** engines D08 · D20 · D26 · D28 (except marine engines)
- Suited to the very limited space conditions in the cylinder head
- Due to the tool's claw, the injector in the upper part may be gripped without causing damage
- Length: 174 mm



Made in Germany

4797-5

EAN-No. 4000896176137

### Impact extractor

- For removal of fixed common rail injectors without removing the cylinder head
- Impact extractor (sliding hammer – sliding weight 200 g) with coupler thread M10
- Removal of caps with inside thread, ball bearings, washers etc.
- Together with stud bolt set 1788T-1/6 and internal extractors 1788N-15 to 35
- Length: 226 mm



Made in Germany

1788T-1

EAN-No. 4000896134304

To be used in combination



### 1/2" Injection line wrench

- For the operation of the union nut on the high-pressure line on the injection valve-common rail injection system
- Proper operation of the injection line screw connection
- Open double hexagon socket for injection lines
- The tightening torque required by the manufacturer is achieved by using a HAZET torque wrench (please follow the instructions of the manufacturer)

125 1/2"



1/2"

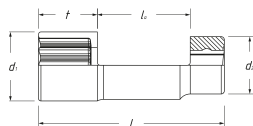

Made in Germany

HAZET No.	S mm	l mm	d <sub>1</sub> mm	d <sub>2</sub> mm	t mm	EAN-No. 4000896+
4550-21	21	91	33	32	19	204137
4550 N-22	22	85	33	32	21,8	234387

### 3/4" Impact socket

- Operation of cylinder head bolts
- Reinforced design
- Long design
- With borehole for locking pin or safety spring and groove for O-ring
- Surface: phosphatized, oiled

20 3/4"



3/4"

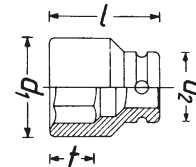

Made in Germany

HAZET No.	S mm	l mm	d <sub>1</sub> mm	d <sub>2</sub> mm	t mm	EAN-No. 4000896+
2850-E20	E20	110	25	44	15	079681
2850-E24	E24	110	30	44	17,5	146758

### 1/2" Pressure nut pin wrench

- Actuation of the compression nut on the nozzle holder
- For **MAN · MERCEDES-BENZ** commercial vehicles M 401/421, M 402/422 · LA · A · M 403/423 · M 470h

125 1/2"



1/2"

Made in Germany

4558

EAN-No. 4000896021888

### 3/8" Injection line wrench

- For operation of screwed connections on injection lines
- Open 12-point socket
- On **MAN** commercial vehicles with D 20 engines – common rail injection systems
- Short design

10 3/8"



s 17 mm

3/8"

Made in Germany

4550-3

EAN-No. 4000896104307

### Turbocharger / manifold socket

- Operation of the turbocharger and manifold screw connection (E12)
- Lower installation height than nut-driver with reversible ratchet
- On **MAN TGL · TGM** with E08 engines

20



E12

s 17 mm

Made in Germany

2871-E12

EAN-No. 4000896201730

Detailed information





**MAXIMUM POWER - PRECISELY TRANSMITTED**

► Our impact sockets are the result of real practical experience - so that you can transfer high torques cleanly and master even tough applications effortlessly.

**3/4" Impact socket**

- E.g. for deeply located wheel nuts and bolts on commercial vehicles
- Extra-long design
- With borehole for locking pin or safety spring and groove for o-ring
- Surface: phosphatized, oiled

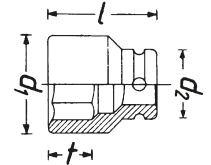

20 3/4"



Made in Germany

HAZET No.	l mm	s mm	d <sub>1</sub> mm	d <sub>2</sub> mm	t mm	EAN-No. 4000896 +
1004S-32	400	32	48	44	32	055784
1004S-33	400	33	48	44	32	055791



Made in Germany

HAZET No.	l mm	s mm	d <sub>1</sub> mm	d <sub>2</sub> mm	t mm	EAN-No. 4000896 +
1104S-32	270	32	48,5	54	30,5	002665



**Four-way rim wrench**

- For passenger cars, vans, people carriers and agricultural machinery
- Forged central piece
- **Tested up to 500 Nm**
- For sockets of series 900
- Surface: chrome-plated, polished head
- Dimensions: 420 mm
- Net weight: 1.73 kg



Made in Germany

**715-01**  
EAN-No. 4000896029464

**Four-way rim wrench**

- For commercial vehicles, tractors, agricultural and construction machinery
- For sockets of series 1000
- Forged central piece
- **Tested up to 2000 Nm**
- Surface: chrome-plated, polished head
- Dimensions: 750 mm
- Net weight: 5.5 kg



Made in Germany

**720-30**  
EAN-No. 4000896029518



Made in Germany

**720S**  
EAN-No. 4000896029532

## Commercial vehicle wheel hub grinder set

12

- Quick and easy removal of rust and dirt from contact surfaces of wheel hubs and brake discs with wheel bolt support
- Grinding pad made of aluminium with 8-point profile enables safe and firm fixation of the grinding wheels
- Hexagon insert for firm hold on the device
- 8-point profile enables safe and firm fixation of the grinding wheel to the base component
- Inside  $\varnothing$  max.: 23 mm
- Grinding wheel  $\varnothing$  56 mm, stud bolt maximum length 100 mm
- Open-pored abrasive material and cup-formed grinding wheel reduce the formation of dust to a minimum
- No formation of sparks

**Contents:**

- 1 base component made of aluminium
- 5 grinding wheels for moderate soiling
- 6 grinding wheels for heavy soiling



**Made in Germany**  
**4961N-23/12**  
 EAN-No. 4000896186754

**Special grinder for optimal cleaning of the bearing surface of a wheel rim (wheel hubs) on trucks and transporters with stud bolts**



## 1/2" Centring sleeve set

12 1/2 3

- Fast assembly of centred commercial vehicle drop centre rim wheels for rim hole  $\varnothing$  26 mm
- For e.g: DAF · FORD · MAN · MERCEDES-BENZ · RENAULT · Volvo
- No damage of the thread as well as exact centring of the rims through conically cranked bushes
- High fitting accuracy thanks to precise thread production



**Made in Germany**

HAZET No.	l mm	Inside thread	EAN-No. 4000896 +
4937-26/3	115	M22 x 1.5 mm	199013
4937-27/3	115	7/8" - 11 G	202010

## 3/4" Universal axle and slotted nut wrench unit tool set

20 3/4 16

- Removal and precise installation of nearly all common axle nuts, e.g. hexagon nuts, 8-point nuts, slotted nuts, face nuts, round nuts with drilled holes, round nuts with pin holes etc.
- Clamping range: 35 – 170 mm
- Maximum torque: 700 Nm
- Plastic box
- Safety-Insert-System, 2-component soft foam insert
- Net weight: 5.1 kg



**772-2/16**  
 EAN-No. 4000896161041





## FITS PERFECTLY. WORKS PRECISELY.

► Our axle nut sockets and pin wrenches have a solid design and high fitting accuracy so that you can work quickly and precisely!

### 3/4" Commercial vehicle axle nut socket

20 3/4"

- Removal / installation of the front axle nut with octagonal in front of the brake disc
- **SCANIA** series R · series 4 · series 124 I - 144 I - etc.
- Parallel surfaces for perfect force fit on axle nuts
- Output: s 80 mm



Made in Germany  
**4937-80**

EAN-No. 4000896199006



### 3/4" Commercial vehicle axle nut socket

20 3/4"

- Front axle screw for **DAF** CF and XF series
- Nut-driver tuned to the axle nut ensures secure mounting of axle nuts
- **DAF**: CF FA · FT · FAR · FAN · FAT · FTT · FTP · FTG · FAD · FTS · FTR · CF 65 FA · CF 75 FA · FT · FAR · FAG · FAT · FAD · CF 85 FA · FAR · FAG · FAN · FAT · FAC · FAX · FAQ · FAD · FT · FTP · FTS · FTR · FTG · FTT · XF FA · FT · FAR · FTP · FAN · FTG · FTT · FAD · FAS · FAT · FAK · FTM · FAG · FAR · XF 95 FA · FAD · FAK · FAN · FAR · FAS · FAT · FT · FTG · FTM · FTP · FTR · FTS · FTT · XF 105 FA · FAR · FAS · FAT · FAK · FAD · FT · FTG · FTS · FTT · FTM
- Output: s 80 mm



Made in Germany  
**4937-S80**

EAN-No. 4000896206889



### 3/4" Commercial vehicle axle nut socket

20 3/4"

- Operation of the rear axle nut on e.g. **IVECO** Daily 6.5 t · 7.0 t
- Guide collar
- Socket completely encloses the flat rear axle nut for safe working
- Parallel surfaces for perfect force fit on axle nuts
- Hexagon drive s 36 mm
- Output: s 90 mm



Made in Germany  
**4937-90**

EAN-No. 4000896199280



### 3/4" Commercial vehicle axle nut socket

20 3/4"

- Operation of the axle nut, e.g. on **SAF** trailer axles for repair and maintenance work
- Hexagon drive s 36 mm
- Output: s 85 mm



Made in Germany  
**4937-85**

EAN-No. 4000896204267



### 3/4" Commercial vehicle oil cap / axle nut socket

20 3/4"

- Operation of the oil cap on the front axle
- For e.g. **IVECO** Stralis and Eurofire · **MERCEDES-BENZ** Discos Trailer with compact bearing hub unit · **BPW** Eco Plus 1 · **BPW** Eco Plus 3 · **GIGANT** trailer axles
- Output: s 95 mm



Made in Germany  
**4937-95**

EAN-No. 4000896199457



### 3/4" Commercial vehicle pin wrench

20 3/4"

- For rear axle nuts **MERCEDES-BENZ** Actros · Atego (heavy design): LN2 · SK rear axle: 740.0/9 – 744.8 745.7 – 747.7 – 748.2HD 7/19 DG 13 · HD4/16-1
- Outside guide collar
- Precise pin geometry for ideal tool operation in pin nuts
- Inside-Ø: 62.8 / 70 mm
- 6 pins, width of pins: 7.5 mm



Made in Germany  
**4937-62**

EAN-No. 4000896199020



### 3/4" Commercial vehicle pin wrench for front axle MAN

20 3/4"

- Pin wrench **MAN** TGX, TGA, TGS all models, model year 2000 →
- For e.g. front axle V9-82L-01 (disc brake with ABS) and **MERCEDES-BENZ** Atego rear axle as well as **MAN** · **MERCEDES-BENZ** · **VAN HOOL** and **NEOPLAN** buses
- Inside Ø: 100.5 mm
- Inside Ø (pin-pin): 92.5 mm
- Outside Ø: 114 mm
- 6 internal pins · 7 mm wide
- Drive 20 3/4" and outside hexagon s 46 mm
- Precise pin geometry for ideal tool operation in pin nuts
- Screw connection tightening torque 750–800 Nm (please observe manufacturer's instructions)
- For **MAN** trucks: E 2000 (ÖAF) · F 2000 · M 2000 L · M 2000 **MMAN** TGA · TGM · TGS · TGX
- **MAN** buses: Lion S City · Lion S Classic · Lion S Coach · Lion S Regio · Lion S Star as well as older constructions (models) · chassis
- **NEOPLAN** Cityliner · Starliner · Tourliner · Trendliner
- **TEMSA** Diamond · **WISEON** high-decker



Made in Germany

**4937-92**

EAN-No. 4000896201952



### 3/4" Commercial vehicle axle nut socket

20 3/4"

- For flat oval **BPW** hub cap
- Perfect fit for **BPW** contour Ø 120 mm



Made in Germany

**4937-120**

EAN-No. 4000896210459



### 1" Commercial vehicle hub cap socket

25 1"

- For flat oval **BPW** hub cap
- For **BPW** Eco and Eco Plus axles
- Perfect fit for **BPW** contour Ø 110 mm



Made in Germany

**4937-110**

EAN-No. 4000896199273



### Mounting sleeve for commercial vehicles

- Use in **MERCEDES-BENZ** Atego, Atego 2, Tourino, Eonic
- Mounting sleeve to protect the thread on the axle during bearing disassembly and assembly
- Only lift the approx. 40 kg bearing unit (bearing, brake disc and wheel hub) onto the mounting sleeve once, then push to the bearing seat with Ø 78 mm
- **Thread: M75 x 1.5**
- **Outside Ø: 78 mm**
- Drive via lateral rod or without additional tools (chequered handle surface)



Made in Germany

**4937-7578**

EAN-No. 4000896201990

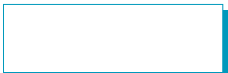

### Mounting sleeve for commercial vehicles

- Use with **MAN** TGL, TGM, L-series, HL 2
- Mounting sleeve to protect the thread on the axle during bearing disassembly and assembly
- Only lift the approx. 40 kg bearing unit (bearing, brake disc and wheel hub) onto the mounting sleeve once, then push up to the bearing seat with Ø 82 mm
- **Thread: M75 x 1.5**
- **Outside Ø: 82 mm**
- Drive via lateral rod or without additional tools (chequered handle surface)



Made in Germany

**4937-7582**

EAN-No. 4000896201969

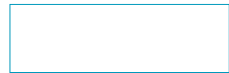

### Mounting sleeve for commercial vehicles

- Mounting sleeve to protect the thread on the bearing journal during bearing disassembly and assembly
- For **SAF** axles with disc and drum brakes with Ø 88 mm bearing seat
- Only lift the approx. 40 kg bearing unit (bearing, brake disc and wheel hub) onto the mounting sleeve once, then push up to the bearing seat with Ø 88 mm
- **Left and right-hand threads M75 x 1.5**
- **Outside Ø: 88 mm**
- Drive via lateral rod or without additional tools



Made in Germany

**4937-7588**

EAN-No. 4000896202003



## 3/4" Pin wrench set

20 3/4" 4

- Removal / installation work on the rear axle as well as repair and maintenance work on the wheel hub, wheel bearing or brake disc rear axle **MERCEDES-BENZ**
- **MERCEDES-BENZ** hub-reduction axle, such as trailing axle NR7/4
- **MERCEDES-BENZ** hub-reduction rear axle (Euro-axles) 10 t and 13 t, HL7/0 · HL7/1 · HL7/2 · HL7/3, HL7/18 · H07/8 · H07/9 · HL7/015, HL7/021 · HD7/2 · HD7/19DG · HD7/016DG
- **MERCEDES-BENZ** hub-reduction axle 7 t AL7/1
- Inside Ø: 101.5 mm
- Total length: 140 mm
- 12 pins, width of pins: 11.4 mm
- Three replaceable guide tubes
- Outside Ø: 50 · 51 · 53 mm
- Total length: 85 mm



Made in Germany

4937-101/4

EAN-No. 4000896199266

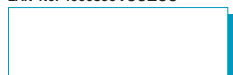

## 3/4" Pin wrench set

20 3/4" 3

- For repair and maintenance work on the wheel hub, wheel bearing or brake disc on **MAN · MERCEDES-BENZ**
- For e.g. **MAN** TGM rear axle 13T/15T with 4x4 drive
- **MERCEDES-BENZ** Atego rear axle HL2
- Pin wrench for rear axle, inside Ø: 87 mm
- Total length: 65 mm
- 6 pins, width of pins: 10 mm
- Two replaceable guide tubes
- Outside Ø: 49 mm · 57 mm
- Total length: 140 mm



Made in Germany

4937-87/3

EAN-No. 4000896199235

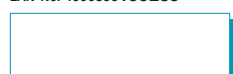

## 3/4" Pin wrench set

20 3/4" 3

- Repair and maintenance work on the wheel hub, wheel bearing or brake disc rear axle for **MAN** and **MERCEDES-BENZ**
- For **MAN** and **MERCEDES-BENZ** 10 t and 13 t AP Hypoid and trailing axle N7/4 · bus 0305G, · 0405G
- **MAN** planetary rear axle F-Series H7 · HD7, Hypoid rear axle F-series HY-1175 · HDY-1175
- Inside Ø: 103 mm
- Total length: 140 mm
- 6 pins, width of pins: 11.5 mm
- Two replaceable guide tubes
- Outside Ø: 51.5 mm · 66.5 mm
- Total length: 135 mm



Made in Germany

4937-103/3

EAN-No. 4000896199259

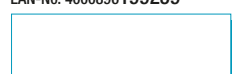

## 3/4" Pin wrench set

20 3/4" 2

- Repair and maintenance work on the rear axle **MERCEDES-BENZ**
- For **MERCEDES-BENZ** Actros · Hypoid rear axle HL 8
- Inside Ø: 117 mm
- Total length: 200 mm
- 6 pins, width of pins: 9.8 mm
- Guide tube
- Outside Ø: 60 mm
- Total length: 185 mm



Made in Germany

4937-117/2

EAN-No. 4000896199242

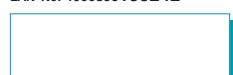

## 1" Axle nut socket set

25 1" 2

- Screw-in guide tube allows for flexible application
- **DAF** with guide tube
- **RENAULT · Volvo** without guide tube
- Outside guide collar
- Total length: 118 mm



s 60 mm | 1"

Made in Germany

4937-105/2

EAN-No. 4000896201938

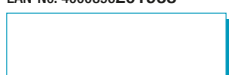

## 1" Pin wrench set

25 1" 2

- For **MAN** TGX, TGA, TGS
- For e.g. rear axle HY 1350
- 6 internal pins · 11 mm wide
- Inside Ø: 134.5 mm
- Inside Ø (pin-pin): 118 mm
- Outside Ø: 148.5 mm
- Total length: 121 mm



s 60 mm | 1"

Made in Germany

4937-111/2

EAN-No. 4000896201945

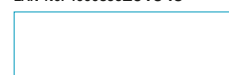



### Universal ball joint puller

- Removing the ball joint pivot from e.g. steering arms, steering tie rods, stabilizers
- Sturdy design and deep location groove enable a safe and universal application, e.g. for light commercial vehicles
- For the most common vehicles
- Jaw opening: 32 mm
- Clamping width: 80 mm

Made in Germany

**1779-3**

EAN-No. 4000896135998



### Ball joint puller

- Removing the ball joint pivot from e.g. steering tie rods, stabilizers
- For e.g. commercial vehicles, **MAN** · **MERCEDES BENZ**
- Jaw opening: 55 mm
- Clamping width: 80 mm

Made in Germany

**1779-55**

EAN-No. 4000896136407



### Quick-clamping puller

- 2-arm
- Inner and outer puller
- Quick adjustment thanks to "one-nut" fixation per arm
- Quick and easy installation
- Forged arms
- High strength and rigidity for safe work
- Solid all-steel bridge

HAZET No.	l mm	sb max. mm	EAN-No. 4000896+
1750-34	354	345	250042
1750-44	354	440	250134

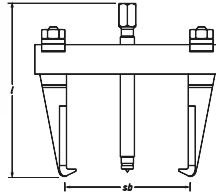

### Quick-clamping puller set

- 2-arm

**Contents:**

- 1750-9
- 1750-11
- 1750-14
- 1750-19
- 1750-26

**1750/5**

EAN-No. 4000896251476



### Removal and assembly fork

- Wedge-shaped fork end allows fast operation of push rod and steering tie rod ends, pitman arms and other parts of the steering
- Proven and economical system
- Easy to handle
- Shock absorber removal and other separation work
- Application in confined spaces
- Sturdy forged design



Made in Germany

HAZET No.	l <sub>1</sub> mm	l <sub>2</sub> mm	b mm	EAN-No. 4000896+
1780-23	340	80	23	133352
1780-29	350	80	29	133376



### Ball joint puller

- Easy extraction of ball joint pivots and safe removal of ball joints
- Hydraulic support
- For passenger cars · vans · commercial vehicles
- Maximum load 12 tonnes

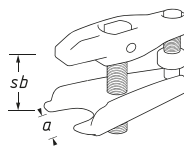

Made in Germany

HAZET No.	a mm	sb mm	EAN-No. 4000896+
1790-5	32	70	145461
1790-6	40	85	145478



### Taper key extractor

- Safe removal of taper keys from the sprockets of agricultural machinery as well as manual operation of input shafts on accessory equipment

Made in Germany

HAZET No.	Design	l mm	EAN-No. 4000896+
4685-1	Straight	420	222889
4685-2	Bent	366	222896



## Lifting aid

- Secure retention and movement of heavy components e.g. when disassembling and assembling brake callipers and wheel hubs on commercial vehicles
- Allows you to work safely, without straining your back, in tight spaces in the wheel arch on trucks, buses, trailers and trailer axles
- Lifting aid consisting of lifting aid 4972-3, brake calliper holder 4972-1 and wheel hub holder 4972-4
- Maximum load: 75 kg
- Makes fitting screws easier
- Takes the various installation situations of the brake callipers into consideration
- Easy to use
- One-hand operation via spindle
- Second person not required
- Setting range: 716 – 911 mm



**Made in Germany**  
**4972-1/3**  
 EAN-No. 4000896215799



Detailed information



## Swivel bearing

- Secure retention and movement of heavy components e.g. when disassembling and assembling brake callipers and wheel hubs on commercial vehicles
- Allows you to work safely, without straining your back, in tight spaces in the wheel arch on trucks, buses, trailers and trailer axles
- Use with brake calliper holder 4972-1
- For disassembly and assembly of brake callipers in trucks, buses, trailers and trailer axles that are installed in a diagonal "clockwise position between 8 o'clock and 5 o'clock"
- Easy to set the screws, even in awkward positions
- Connect swivel bearing to brake calliper holder and place under the brake calliper with e.g. lift truck
- Takes the various installation situations of the brake callipers into consideration
- One-hand operation via spindle
- Second person not required
- Setting range: 716 – 911 mm

**Made in Germany**  
**4972-2**  
 EAN-No. 4000896215393

Makes fitting screws easier



## Brake calliper resetting tool

- Resetting **WABCO** brake callipers without removing the brake cylinder on **MERCEDES-BENZ** Actros, Antos, Arocs
- Special insert in the ratchet wrench ensures safe power transmission on the resetting device
- Length: 454.4 mm



≤ 8 mm

**Made in Germany**  
**4971-12**  
 EAN-No. 4000896232857



## Brake calliper resetting tool KNORR Bremse

- Operation of the adjuster (adjusting the brake calliper) on **KNORR** Bremse disc brakes on trucks, buses, trailers and trailer axles from all brands
- Adjusting with nut-driver ≤ 12 mm
- Special 11-tooth profile
- Length: 18 mm



**Made in Germany**  
**4971-11**  
 EAN-No. 4000896218257

## Brake calliper socket

- Operation of the brake calliper screws on **MAN** commercial vehicles
- For e.g. **MAN TGM · TGA (E18 · E20)** and **MAN TAG · TGS · TAX (E24)**
- Operation e.g. with **HAZET** insert box-end wrench 6630d-22together with tool holder 6397 (loosening) or torque wrench 6293-1CT or 6295-1CT (tightening)
- Length: 39.5 mm



**Made in Germany**

HAZET No.	S	d	Hex	EAN-No. 4000896 +
2871-E18	E18	23,4	22	176175
2871-E20	E20	25,7	22	148790
2871-E24	E24	35	22	148783



### 3/4" Box-end wrench - striking face pattern with 2 striking faces

- Operation of brake calliper screws in commercial vehicles
- The 12-point profile allows application even in areas with hard-to-reach screw connections
- Controlled screw tightening with torque wrench according to manufacturer's specifications
- Spanner flat with laser-engraved formula for calculating the correct effective length

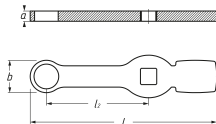

Made in Germany

HAZET No.	S mm	l mm	l <sub>2</sub> mm	a mm	b mm	EAN-No. 4000896 +
2872SZ-24	24	219	120	12	38	204175
2872SZ-26	26	219	120	12	38	203727
2872SZ-27	27	220,5	120	12	38	207183
2872SZ-30	30	220,5	120	12	45	246281

### 3/4" Box-end wrench - striking face pattern with 2 striking faces

- Operating the tight cardan shaft screw connection, even when the space is limited
- The 12-point profile allows application even in areas with hard-to-reach screw connections
- For MAN Nkw (4937-21) and MERCEDES-BENZ commercial vehicle (4937-19) cardan shaft screw connections
- Laser-engraved formula for rapid conversion of the tightening torque specified by the manufacturer
- Especially suitable for all repairs on the go, where no working pit is available
- 2 striking surfaces enable the force to be applied using a hammer
- Highly stable and resilient



Made in Germany

HAZET No.	S mm	l mm	l <sub>2</sub> mm	a mm	b mm	EAN-No. 4000896 +
4937-19	19	215	120	12	30	215645
4937-21	21	215	120	12	30	215638

### 3/4" Box-end wrench - striking face pattern with 2 striking faces

- Operation of TORX® screws on brake calliper screw connections on commercial vehicle front axles and trailing axles
- No need to remove the steering tie lever
- For e.g. MAN TGL · TGM (E18 · E20) MAN TGA · TGS · TGX and MERCEDES-BENZ Atego 970-976 (E24)
- Controlled screw tightening with torque wrench according to manufacturer's specifications
- Wrench face with laser-engraved formula for calculating the correct effective length

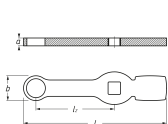

Made in Germany

HAZET No.	S mm	l mm	l <sub>2</sub> mm	a mm	b mm	EAN-No. 4000896 +
2872-E18	E18	215	120	12	30	201235
2872-E20	E20	216	120	12	32	201242
2872-E24	E24	219	120	12	38	201259

### 1/2" Box-end wrench - striking face pattern with 2 striking faces

- Operation of brake cylinder screw connections
- Even for brake cylinder screw connections protruding far into the rim
- Laser-engraved formula for rapid conversion of the tightening torque specified by the manufacturer
- 2 striking surfaces enable targeted force application
- About 20 minutes time saving
- Highly stable and resilient



Made in Germany

2872FS-24  
EAN-No. 4000896209989

Use on trucks, buses, trailers and trailer axles without removing the wheel

### Releasing tool for compressed air quick-connectors

- Easy loosening of quick-connectors with Ø 6 · 8 · 10 · 12 mm
- For operation with open-end wrench s 13 mm (HAZET 600N-13), no further tools necessary
- For plug connectors DIN 74324 6 x 1.0 · 8 x 1.0 · 10 x 1.0 · 12 x 1.5 · 12 x 2.0 mm
- Separation of contaminated tubes and plug connectors
- To be used by one person
- Prevention of injuries
- Time and cost saving



Made in Germany

4969-612  
EAN-No. 4000896204281



### 3/4" Brake calliper screwdriver socket - 14 mm

- Operation of the brake calliper screw connection (KNORR Bremse) on MERCEDES-BENZ passenger car, e.g. Actros
- Operation of the upper wishbone screw on MAN TGA
- Drive allows transmission of high separation forces
- Controlled screw tightening with the torque required by the manufacturer (please follow the instructions of the manufacturer) e.g. with HAZET 6144-1CT torque wrench



Made in Germany

2784-14  
EAN-No. 4000896155583

## Digital current clamp meter

- Measuring voltage, current and resistance
- Simple operation thanks to clear control panel and illuminated LCD display
- For use in areas with restricted access
- Voltage tester (non-contact)
- Current measurement alternating current (AC) · direct current (DC) without disconnecting the line
- NCV (Non-Contact Voltage) function
- Measurement category CAT III 300 V, CAT II 600 V
- Capacitance measurement up to 20 µF
- Pliers opening Ø 17 mm
- Multimeter: continuity test · diode test · data hold · auto power-off function (15 minutes)
- Storage bag · Protective cover
- Including CAT III test lead set
- Suitable for measuring quiescent current, as small currents from 1 mA are detected



Three measuring devices in one:

1. Current clamp meter
2. Multimeter
3. Voltage tester (non-contact)

2152-610

EAN-No. 4000896268542



Extra short only 175 mm



## Multimeter

- For measuring voltage, resistance, frequency, capacitance and temperature
- Protective cover protects multimeter against damage from being dropped
- Including measuring tips for clipping into the protective cover
- Including temperature probe from -20°C to 200°C
- Including 2 x AA batteries
- DC voltage: 0 – 600 V
- AC voltage: 0 – 600 V
- Direct current: 0 – 10 A
- Alternating current: 0 – 10 A
- Resistance: 0 – 60 MOhm
- Diode test
- During the continuity test, the integrated buzzer signals continuity below 50 Ohm
- Frequency: 0 – 10 MHz
- Duty cycle
- Capacitance measurement: 0 – 60 MOhm
- Automatic switch-off
- Data hold
- True RMS
- CAT III 600 V

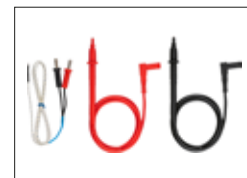

2152-600

EAN-No. 4000896246762



## Universal shears

- Cutting thin sheet metal, wires, plastics, balanced weights, carpets, etc.
- Additionally with round cutter for wire stripping (1 or 1.5 mm<sup>2</sup>)
- Wire guide for cutting binding wire up to Ø 2.5 mm
- Locking device
- HAZET 2-component handle
- Length: 194 mm



2158

EAN-No. 4000896057856



Stainless steel blades

## Electronic set

- Troubleshooting in electronic components
- Testing device for motor vehicle electrical systems and electronics
- 3–48 V
- Voltage display: LED 5 V · 12 V · 24 V · 48 V
- Polarity display: LED for positive or negative, AC voltage with illuminated LED
- Probe tip, needle with sliding mechanism
- Additional: Crocodile clip and probe tip for attaching
- Cable length: 1300 mm



2152N/3

EAN-No. 4000896204151



## Wire stripper · automatic

- Stripping of flexible cables (stranded wire) and solid conductors Ø 0.2 – 6.0 mm<sup>2</sup> or AWG 24 – 10
- Automatic scanning system, no adjustment to the cable cross-section necessary
- Optimally positioned diagonal cutter up to 2.5 mm<sup>2</sup>
- Adjustable length stop: 6 – 15 mm
- Fastening element at the end of the handle
- Length: 165 mm



Made in Germany

1862N

EAN-No. 4000896242627



## Special tool for battery plugs

- Screwing battery plugs in and out
- Special length allows universal application in areas with restricted access
- Profile is especially suitable for battery plugs
- Length: 95 mm



Made in Germany

4650-3A

EAN-No. 4000896249275



s 1,7 x 14,5 mm

## Battery pole and terminal brush

- Cleaning the terminal posts and clamps
- Protection cap
- Length: 120 mm



Made in Germany

4650-4

EAN-No. 4000896022038



**HIGHLIGHTS!**

- ① Guide handles prevent contact with greasy surfaces and ensure optimum handling when hanging freely
- ② Safety bolt prevents slipping out in the event of a defective or incompletely engaged fifth wheel coupling and has been tested to more than 3 times the load of the fifth wheel coupling.
- ③ Integrated anti-rotation device optimises handling in the air and ensures stability during suspension

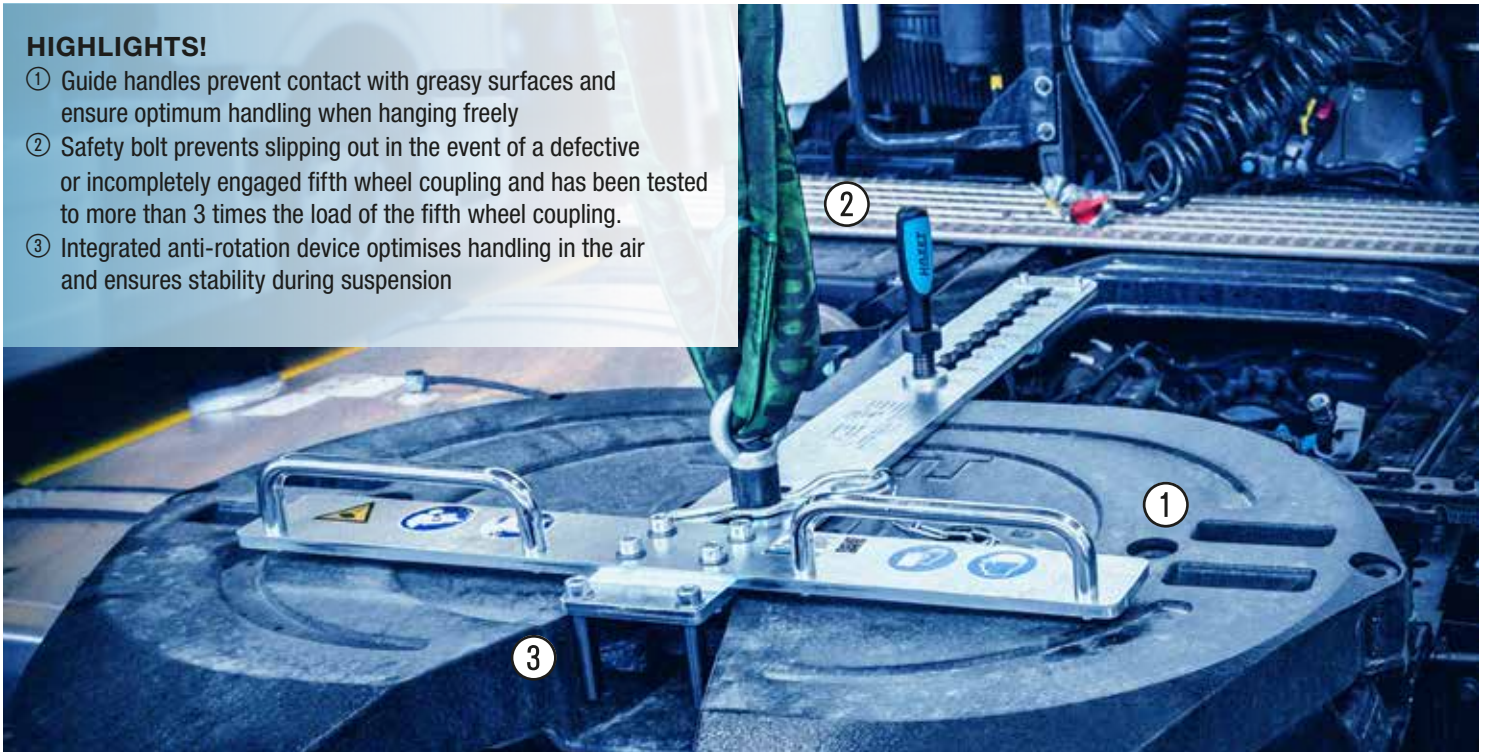

**Fifth wheel plate lifting aid**

- Installed coupling pin ensures perfect stabilisation of the fifth wheel plate
- Centre of gravity-optimised guidance
- Safety bolt (quick-release fastener) prevents slipping out
- Integrated anti-rotation device
- Handles for clean and safe guidance
- Kingpin in 2" and 3.5" enables easy replacement and high flexibility
- Nominal load: up to 330 kg

**NEW!**



**Made in Germany**



Bauart geprüft  
Sicherheit  
Regelmäßige  
Produktions-  
überwachung



www.tuv.com  
ID 1111299117

TÜV-certified special tool

**Thanks to integrated bolts, manoeuvrability is guaranteed during free-floating!**

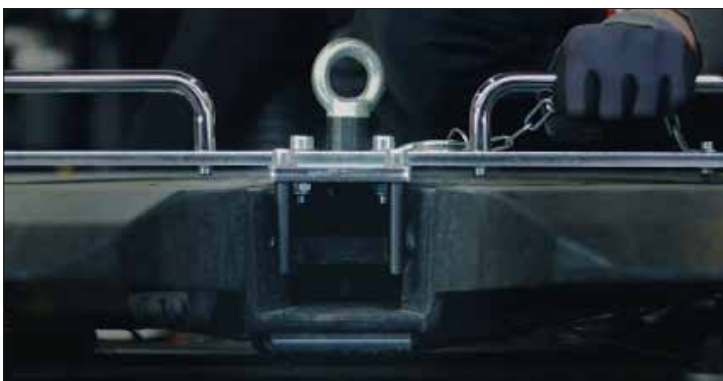

**Viewing window on the spigot for checking the engagement process!**

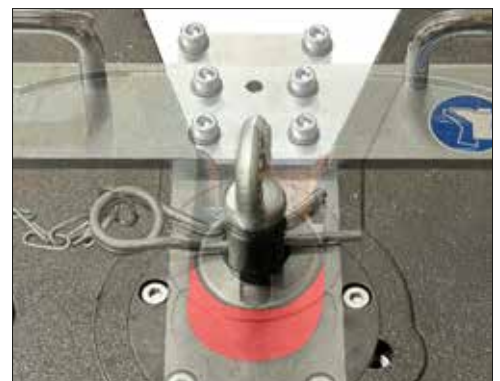

**Made in Germany**

**4972-5**

EAN-No. 4000896268641

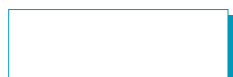



# Assistant® 179NWL-7



Das Werkzeug

Continuous drawer width!

## HEAVY LOAD!

New mobile work bench 179NWL-7 with 513 professional tools

179NWL-7/513  
EAN-No. 4000896280582



751LHS/5-1

163-515/16



163-679/37

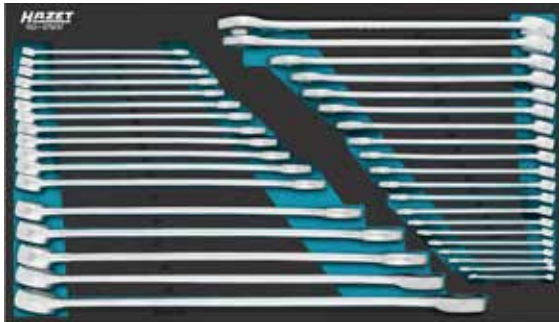

163-676/25



163-644/266



163-677/3



163-619/35



163-675/45



163-678/12



30 mm wood multiplex birch work surface, oiled on both sides, replaceable

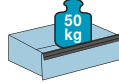

965 mm



179NWL-7  
Made in Germany

1150 mm

600 mm

Including  
**HiPer**  
90 teeth · 4° ·  
1000 Nm (1/2")

163-680/37



163-172x398



163-681/21



163-172x50

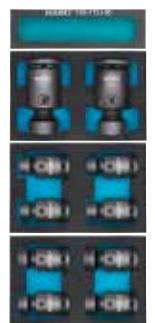

Your HAZET specialist dealer:

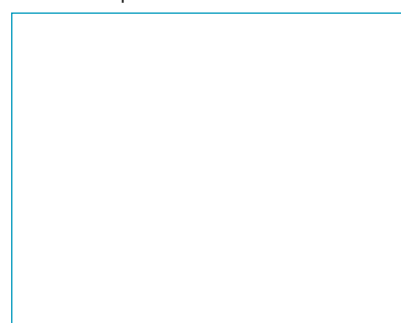

1000SG-2224/2  
900SG-1316/4  
900SG-1721/4

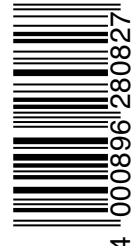

Copyright © 2026  
HAZET-WERK Hermann Zerver GmbH & Co. KG  
Güldenwerther Bahnstraße 25-29,  
D-42857 Remscheid, Germany

\*Recommended promotion prices excl. VAT – Prices valid from 1 March 2026 until 28 February 2027 at the latest. Prices are subject to change before 28 February 2027 in the event of increased purchase or production costs – errors excepted. We accept no liability for printing errors! All rights reserved regarding technical modifications and errors. Images may not always correspond to originals and are thus non-binding! © 2026