

SPECIAL 2023/ 2024 WORLDWIDE

New Products and Specials



LIMITED EDITION 01/100



OFFICIAL SUPPLIER

PORSCHE
MOTORSPORT



LIMITED EDITION

Valid from 1 September 2023 until 29 February 2024. Errors excepted.

SWW2324/EN/XX/0

179N

- Plastic work surface



3/3+	
------	--

HAZET No.	Number of drawers	EAN-No. 4000896+
179N-6	6	214570
179N-7	7	214488
179N-8	8	214587
179N-9	9	220236

179NX

- Stainless steel work surface



3/3+	
------	--

HAZET No.	Number of drawers	EAN-No. 4000896+
179NX-6	6	215560
179NX-7	7	215577
179NX-8	8	215584

179NXL

- Stainless steel work surface



4/3+	
------	--

HAZET No.	Number of drawers	EAN-No. 4000896+
179NXL-6	6	215171
179NXL-7	7	215164
179NXL-8	8	215218

179NXXL

- Stainless steel work surface



5/3+	
------	--

HAZET No.	Number of drawers	EAN-No. 4000896+
179NXXL-7	7	214624
179NXXL-8	8	214778

179NXXL-8D/3

- Stainless steel work surface



Over
30%
more
drawer depth!

1/2++	1/2++
-------	-------

HAZET No.	Equipment	Number of drawers	EAN-No. 4000896+
179NXXL-8D/3	With lateral door and socket strip	8	245178
179NXXL-8D	Without lateral door and socket strip	8	242931

179ND-75

- Vice fastening for 179NXXL-8D · 179NXXL-8D/3

Made in Germany

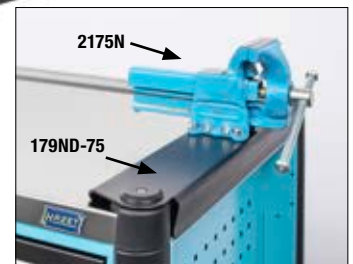

NEW!

HAZET No.	Designation	EAN-No. 4000896+
179ND-75	Vice fastening for 179NXXL-8D · 179NXXL-8D/3	252343
179N-75	Vice fastening for 179N · 179NX · 179NXL · 179NXXL	241835
2175N	Machinist's vice	013685

SIMPLE AND QUICK TESTING OF TORQUE WRENCHES

NEW!



- Easy input of up to 15 different target values
- Precision $\pm 1\%$ (maximum display deviation)
- 3 measurement methods
 - Automatic click point detection (first peak · click)
 - Peak value measurement (final peak · dial)
 - Tracking measurement / display value (track)
- Triple signalling of the measurement result:
 - Digit display in 17 mm font size
 - Traffic light function for assessing the torque value
 - Audible signal
- Robust aluminium housing for workshop use
- Self-sufficient operation possible via power bank (5V · 1A)
- Calibrated measuring range in the clockwise direction of rotation (7903E: measurements from 1 Nm are possible with a display deviation of approx. $\pm 2\%$)
- Quick test function
- Compatible with HAZET test software torque testing 7901E-D, micro USB socket for power supply and data transmission
- Menu languages: German, English, French, Spanish, Italian, Danish, Finnish, Swedish, Norwegian, Portuguese
- Included in delivery:
 - USB mains adapter 90–264 Volt AC. Including mains plug adapters for EU · UK · USA · AUS
 - Cable (2.0 m) USB 2.0 A plug – USB 2.0 micro B plug
 - Calibration certificate and quick reference guide (detailed operating instructions online for download)

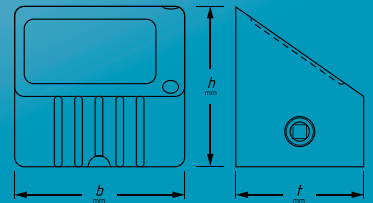

Simple, intuitive operation



Large LCD display with traffic light function for evaluation of the measured value



Supplied in a sturdy plastic case with soft foam insert



Protection rating: IP40. Spray-water-proof



1.5 – 30 Nm

7903E

EAN-No. 4000896167425



w	h	d
mm	mm	mm
175	64	72



10 – 350 Nm

7901E

EAN-No. 4000896140671



w	h	d
mm	mm	mm
138	110	117



50 – 1100 Nm

7902E

EAN-No. 4000896150229



w	h	d
mm	mm	mm
160	120	132.5



Open hose reel

- Allows visual inspection of the hose
- Automatic hose reel offers tidiness in the workshop – hose not left lying around, thus reducing the risk of accidents
- Open design against accumulation of dirt
- For compressed air
- Inside diameter of the hose: 10 mm
- Hose length: 20 m
- Max. working pressure: 12 bar
- Spring return with ratchet locking holders
- Including sturdy swivel base
- Integrated roller inlet
- Hybrid polymer hose, black
- Length of connection hose: 1 m
- Air inlet: outside thread 16.41 mm (3/8")
- Including German air connection nipple for air inlet 9000-015
- Can be used with HAZET safety clutch 9000-061
- Installation via metal bracket or swivel base (included)
- Weight: 11.68 kg

NEW!

**Sturdy steel design
with ball-bearing guiding rails!**

9040 OS-10
EAN-No. 4000896252602

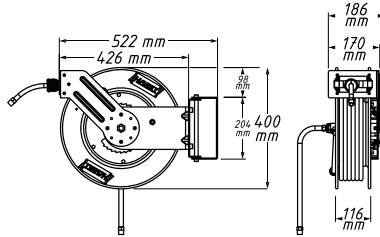

9000-015

Solid steel construction

Swivel range: 180°

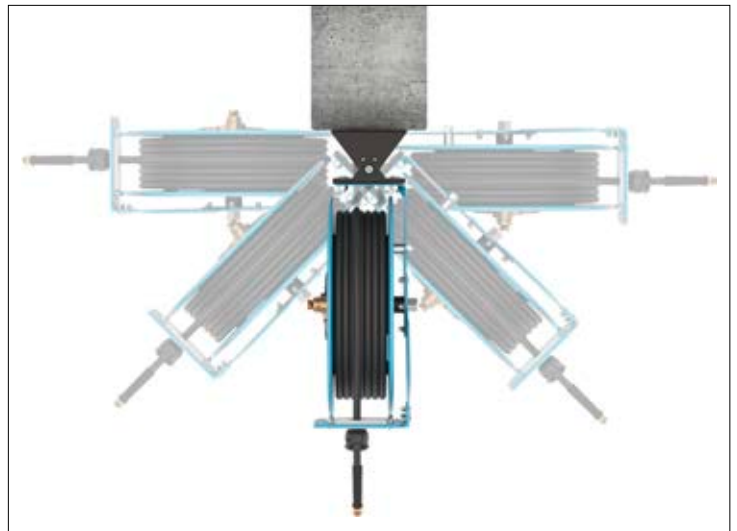

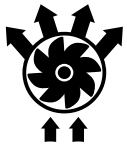

Twin Turbo

Extremely compact

1/2" Twin Turbo palm impact wrench, loosening torque maximum: 550 Nm

- Operation of difficult-to-access screw connections in / on machines, steel constructions and vehicles
- Operation of brake calliper, strut bearing, shock absorber and steering screw connections as well as other hard-to-reach screw joints
- Low reaction forces
- Max. tightening torque: 500 Nm
- Exhaust air is guided through the handle
- High performance twin hammer mechanism
- Air inlet: inside thread 12.91 mm (1/4")
- Coupler plug: nominal size 7.2 (included)
- Recommended torque: 450 Nm
- Hose diameter (recommended): 10 mm
- Sound power level (at working pressure): 103.9 dB(A) Lp W
- Sound pressure level (at working pressure): 92.9 dB(A) Lp A
- Vibration acceleration: 7.64 m/s²
- Loosening torque (max) determined with screw size: M16
- Forward/reverse: single-stage (right/left)
- Revolutions per minute: 8,000
- Air requirement: 113 l/min
- Weight: 1.1 kg

9012PTT

EAN-No. 4000896252732



Recommendation: 9000-041

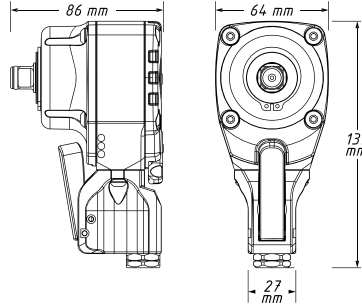

NEW!



Comparison with 9012ATT

Rear view



Turbo air blow gun

- Cleaning of soiled surfaces such as upholstery surfaces, dirt from wheel housings, floor mats from animal hair as well as for vehicle preparation, rim and parts cleaning with compressed air and as preparatory cleaning work for the installation / removal of parts
- Swirl nozzle generates a strong air pulse for cleaning even stubborn soiling
- To be used on machinery, vehicles, in workshops, for wood work, in hobby workshops
- Highly practical design
- Air inlet: inside thread 12.91 mm (1/4")
- Coupler plug: nominal size 7.2 (included)
- Hose diameter (recommended): 10 mm
- Max. pressure (bar): 12
- Sound pressure level (at working pressure): 91 dB(A) Lp A
- Sound power pressure (at working pressure): 102 dB(A) Lp W
- Air requirement: 80 l/min (at working pressure)
- Weight: 0.163 kg

9040T-1

EAN-No. 4000896252626

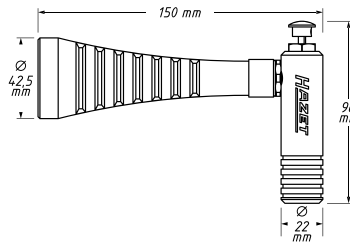

Plastic housing protects against scratches

Extremely effective due to swirled air impact!

NEW!





Magnetic holder

- Handy texture
- Rubberised contact surface
- HAZET own product design
- Suspension of pneumatic or water hoses as well as bags or rucksacks
- Holder dimensions: L 86.5 mm, Ø 72 mm
- Logo dimensions: L 72 x W 29 x H 13 mm
- Magnetic holding force: axial max. 18 kg

Made in Germany

197-10

EAN-No. 4000896254392

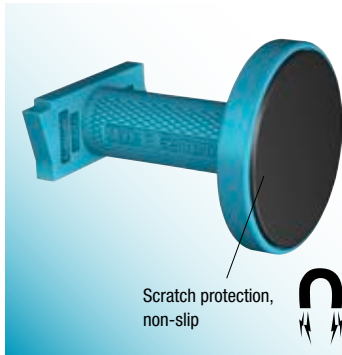

Scratch protection, non-slip



HAZET logo magnet!

Figure in original size:
L 72 x W 29 x H 13 mm

Magnetic button set

- Attachment of drawings or other information sheets to metallic surfaces
- Universal application
- Magnetic holding force: max. 3 kg
- Contents: 3 magnetic buttons

3

NEW!



Made in Germany

197-11/3

EAN-No. 4000896255191



Mechanic's creeper

- Especially deep for maximum freedom of movement under the vehicle
- Solid one-piece construction made of high strength plastic, black
- Ergonomically shaped: cut out arm areas for optimal elbow room
- Smooth-running swivel castors with rubber running surface, oil resistant and low-noise
- Practical carrying handle in the foot area
- Dimensions: L 1,030 x W 480 x H 115 mm



NEW!

195N-2

EAN-No. 4000896252169



Six castors made of hard plastic (Ø 70 mm). Resilient up to 150 kg

Practical storage compartments for tools and small parts on the right and the left

Headrest softly upholstered



1/2" special screwdriver socket set

- Operation of wheel bearing screw connection in the aluminium housing on **AUDI** and **VW** vehicles as well as **SEAT** and **ŠKODA**
- Enables loosening of the wheel bearing bolts without removing the drive shaft and ball joint – time saving: approx. 35 min.
- Taper on the shaft allows it to get past the drive shaft joint
- Ideal for confined spaces
- Blade with TiN coating
- 2 lengths available for 4-link axle and McPherson spring struts
- Output: internal serration profile XZN M12
- For manual operation

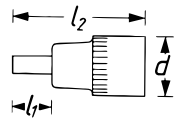
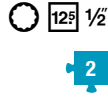

l_1 mm	l_2 mm	d mm
41	74	23



Why choose TiN (Titanium Nitride) coating?

TiN

- A special coating process for extremely hard TiN coating guarantees high adhesive strength and wear resistance of the coating
- Ideally suited for continuous loads
- Higher wear protection guarantees a longer lifetime
- Perfect fitting accuracy due to optimum coating thickness
- Optimized corrosion protection

Short design



12.5 1/2

○ M12

Made in Germany
2584-12/2
EAN-No. 4000896252640

Long design



12.5 1/2

○ M12

l_1 mm	l_2 mm	d mm
81	114	23

3/8" drive shaft screwdriver socket

- Actuation of the stub shaft on **AUDI** and **VW** vehicles as well as **SEAT** and **ŠKODA**
- Loosening and tightening of the fastening screws on the heat protection plate when removing the drive shaft
- Universal use for deep screw connections
- Can also be used for gearbox repair
- Torque-controlled screw tightening, e.g. with HAZET 5110-3CT possible (Please follow the manufacturer's specifications)
- Extra long design
- Output: inside hexagon profile
- For manual operation

10 3/8



○ S 6 mm



10 3/8

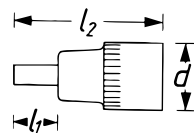

l_1 mm	l_2 mm	d mm
332	359	19

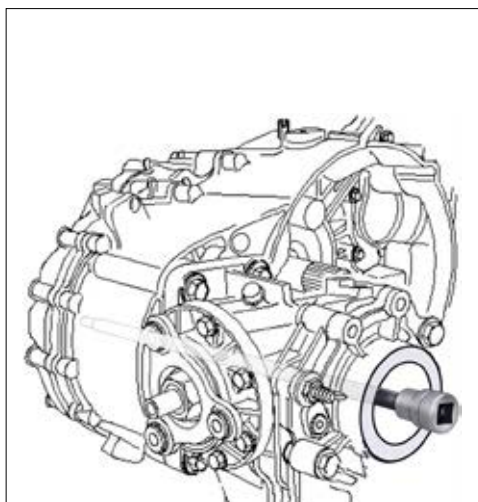

Made in Germany
2584LG-1A
EAN-No. 4000896252817



EXHAUST PROBE SOCKETS

- ▶ Removal and installation of the lambda probe, particle sensor, NOX sensor and exhaust temperature sensor
- ▶ Double square drive 12.5 = 1/2"
- ▶ Additional hexagon drive
- ▶ Also suitable for closing the slot to avoid widening the opened hexagon
- ▶ Torque-controlled tightening possible
- ▶ For manual operation
- ▶ Surface: phosphatized, oiled
- ▶ Dimensions: L 66 x H 39 mm
- ▶ Slot width: 8 mm

NEW!



Sturdy design for tight exhaust probes!

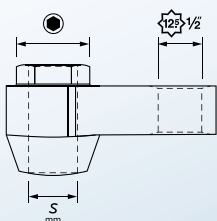

Additional hexagon drive



Suitable for all passenger car and commercial vehicle models

NEW!

● s 24 mm

s 14 mm

Made in Germany
4680-7
EAN-No. 4000896254118

NEW!

● s 24 mm

s 17 mm

Made in Germany
4680-8
EAN-No. 4000896254132

NEW!

● s 24 mm

s 19 mm

Made in Germany
4680-9
EAN-No. 4000896254156

NEW!

● s 30 mm

s 22 mm

Made in Germany
4680-5
EAN-No. 4000896057870

NEW!

● s 30 mm

s 24 mm

Made in Germany
4680-6
EAN-No. 4000896252268

Supplement



Lambda probe sockets



●

Made in Germany

	HAZET No.	S mm	l mm	EAN-No. 4000896+
①	4560	17 x 17	221	021918
②	4680-1	22	92	165605
③	4680-2	22	110	022090
④	4680-3	22	110	022106

SPECIAL TAP FOR EXHAUST TEMPERATURE SENSORS / PROBES

NEW!

- ▶ Professional **repair**, cleaning or repairing of the mounting threads of the exhaust temperature sensors / probes
- ▶ Guide bolt prevents jamming of the thread repair tool, thereby enabling exact repair or cleaning of the sooted or damaged thread
- ▶ Time saving: replacement of the exhaust system is no longer necessary in most cases
- ▶ No tilting or jamming during repair
- ▶ With guide bolts and cleaning grooves
- ▶ Short design enables use in confined spaces
- ▶ 6 cutting surfaces for optimal fitting accuracy as well as easy and quick handling
- ▶ High-quality TiAlN coating for longer service life
- ▶ Suitable for application on stainless steel components
- ▶ Drive: ≤ 13 mm



Cutting surface / cleaning groove



Guide bolts



Why TiAlN (titanium aluminium nitride) coating?

TiAlN

- Suitable for dry machining
- Ceramic surface minimizes friction
- Optimum service life
- Temperature-resistant to 800°C
- No coolant necessary

Defective probe / component



Defective lambda probes



Thread size: M12 x 1.25

- For exhaust temperature sensors on: **NISSAN · RENAULT · BMW · MINI · CITROËN · PEUGEOT · FORD · HYUNDAI · KIA · DACIA · MERCEDES-BENZ · OPEL · VAUXHALL · SUZUKI · IVECO**
- Length: 55 mm



Made in Germany

4683-12

EAN-No. 4000896253555

Thread size: M14 x 1.5

- For exhaust temperature sensors on: **MERCEDES-BENZ · AUDI · PORSCHE · SEAT · ŠKODA · VW · FIAT · ALFA ROMEO · LANCIA · OPEL**
- Length: 45 mm



Made in Germany

4683-14

EAN-No. 4000896253579

Thread size: M16 x 1.5

- For exhaust temperature sensors on: **MERCEDES-BENZ** trucks, bus & **DAF** commercial vehicles **ACTROS** (930, 932, 933, 934, 938) · **AXOR** (375, 940, 942, 943, 944, 950, 952, 953, 954, 958) · **ATEGO** (375, 950, 952, 953, 954, 958) · **MB** Bus O 500 BM382 · **DAF** CF 65 · **DAF** CF 75 · **DAF** CF 85 · **DAF** CF 105
- Length: 43 mm



Made in Germany

4683-16

EAN-No. 4000896253593

Thread size: M18 x 1.5

- For lambda probes on: **MERCEDES-BENZ · AUDI · PORSCHE · SEAT · ŠKODA · VW · FIAT · ALFA ROMEO · LANCIA · BMW · OPEL · CHEVROLET · DAEWOO · SUZUKI · FORD · HONDA · TOYOTA · NISSAN · Volvo · CITROËN · SAAB · SUBARU · MAZDA · MINI · MITSUBISHI · JAGUAR · ROLLS ROYCE · BENTLEY · LEXUS · PONTIAC**
- Length: 42 mm



Made in Germany

4683-18

EAN-No. 4000896253616

Thread size: M20 x 1.5

- For NOX sensors on: **DAF · MERCEDES-BENZ TRUCKS · IVECO · MAN · SCANIA · RENAULT TRUCKS · Volvo TRUCKS**
- Also suitable for passenger car models where a NOX sensor or particle filter sensor with thread M20 x 1.5 is installed. e.g. **BMW · AUDI · VW · OPEL · MERCEDES-BENZ**
- Length: 50 mm



Made in Germany

4683-20

EAN-No. 4000896253630

Thread size M22 x 1.5

- For particle filter sensors on: **AUDI · VW · PORSCHE · OPEL · MERCEDES-BENZ · BMW · GENERAL MOTORS · MAN**
- Length: 50 mm



Made in Germany

4683-22

EAN-No. 4000896253654

1/4" screwdriver joint socket XZN

- Operation of the fastening screws of the 4/2 way valve with coolant regulator (note: coolant regulator is located inside the coolant pipe and cannot be renewed individually)
- With joint for use in hard-to-reach places and to bypass interfering edges: fastening screws are located behind the oil filter and cannot be reached in a straight line
- Application e.g. on: 4-cylinder diesel engine (2.0l Common Rail):
AUDI A3 model year 2003 – 2013, TT model year 2008 – 2014, A1 model year 2011 – 2015, Q3 model year 2011 – 2018
SEAT Altea model year 2004 – 2015, Leon model year 2005 – 2012, Altea model year XL 2006 – 2015, Alhambra model year 2010 – 2022
SKODA model year Octavia 2004 – 2013, Superb model year 2008 – 2015, Yeti model year 2009 – 2017
VW Caddy model year 2010-2015, Eos model year 2008-2015, Golf Plus model year 2008-2015, Passat model year 2010 – 2017, Passat CC model year 2008 – 2016, Scirocco model year 2008 – 2017, Golf 6 model year 2008 – 2012, Touran model year 2010 – 2015, Beetle model year 2011 – 2016, Jetta model year 2010 – 2018, Tiguan model year 2007 – 2018
- Output: internal serration profile XZN M8

NEW!

6.3 1/4"

Made in Germany
2548G-XZN8
 EAN-No. 4000896252701

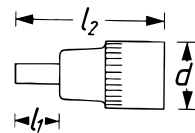
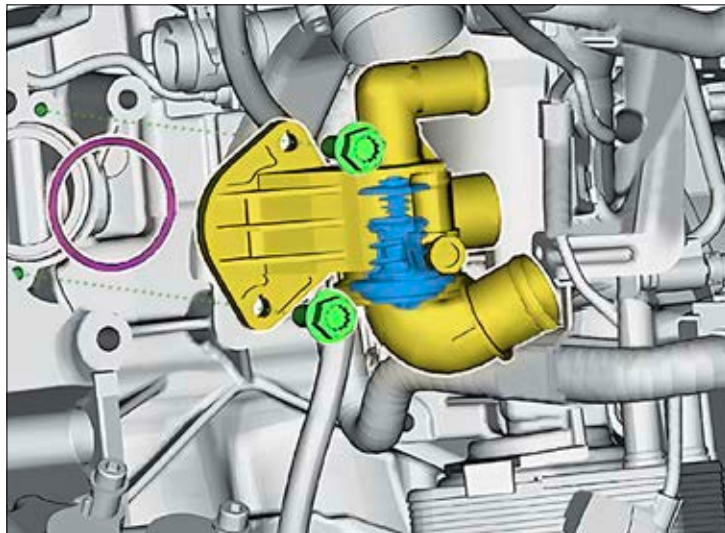

l_1 mm	l_2 mm	d mm
10	39.5	14



Brakes

Hand brake shoe retaining spring tool

- Tool is especially suited to areas with very restricted access
- Operation of retaining springs of the hand brake shoes (rear disc brakes)
- Universal use possible in confined spaces due to s 5 mm
- Application e.g. on: **BMW** E36, E46, E39, E60, E85
- Tool makes it easy to reach the retaining springs on the side behind the wheel hub, as operation through borehole in the wheel hub is not possible for the above vehicle types
- T-handle with dip-coating
- Total length: 155 mm

NEW!

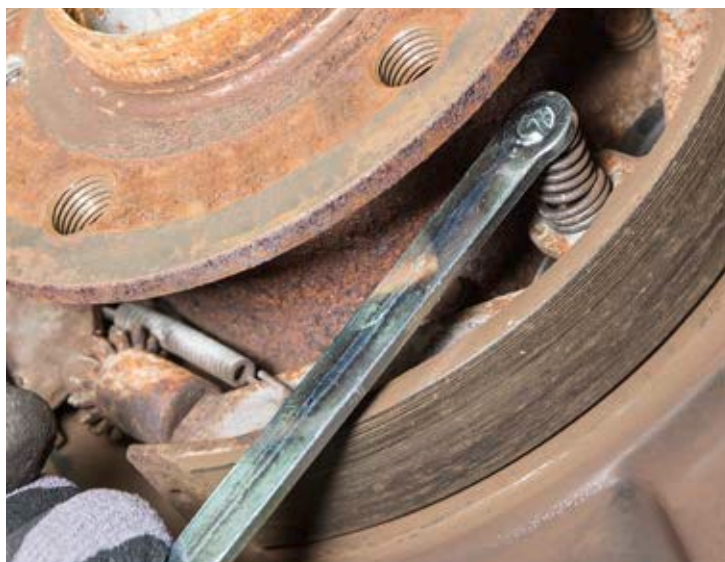

Made in Germany
2730-2
 EAN-No. 4000896254286

TOOLS WITH NEW T-HANDLE

- ▶ Ergonomically shaped HAZET 2-component T-handle
- ▶ Hanging hole
- ▶ Functional design

Made in Germany



Exhaust equipment tool

- Installation and removal of rubber retainers on exhaust systems
- Hook 40 mm, bent 9°
- Surface: chrome-plated
- Length: 209 mm

NEW!



Made in Germany
4684-1A
EAN-No. 4000896249305

Exhaust equipment tool

- Installation and removal of rubber retainers on exhaust systems
- Hook 17 mm, half-round, bent 20°
- Surface: chrome-plated
- Length: 209 mm

NEW!

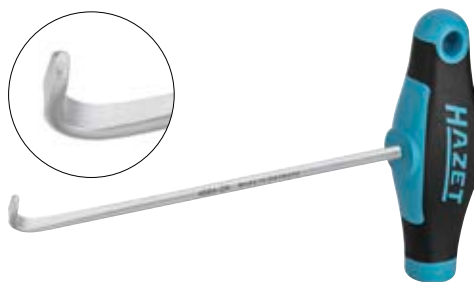

Made in Germany
4684-2A
EAN-No. 4000896249282

Special tool for battery plugs

- Special length allows universal application in areas with restricted access
- Profile is especially suitable for battery plugs
- Surface: chrome-plated
- Wrench size: 1.7 x 14.5 mm
- Length: 95 mm

NEW!

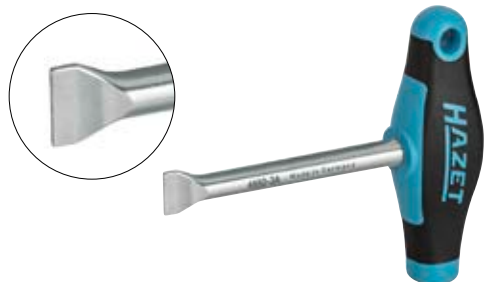

Made in Germany
4650-3A
EAN-No. 4000896249275

Draw spring assembly tool

- Installation and removal of draw springs on hand brake shoes (rear disc brake)
- On e.g. **MERCEDES-BENZ** passenger car as well as Sprinter **VW** Crafter
- Surface: chrome-plated
- Length: 162 mm

NEW!



Made in Germany
4964-1A
EAN-No. 4000896249299

Hand brake shoe retaining spring tool

- Operation of retaining springs of the hand brake shoes (rear disc brakes)
- On e.g. **MERCEDES-BENZ** passenger car as well as Sprinter, **VW** Crafter
- Length: 142 mm

NEW!



Made in Germany
2730A
EAN-No. 4000896249510

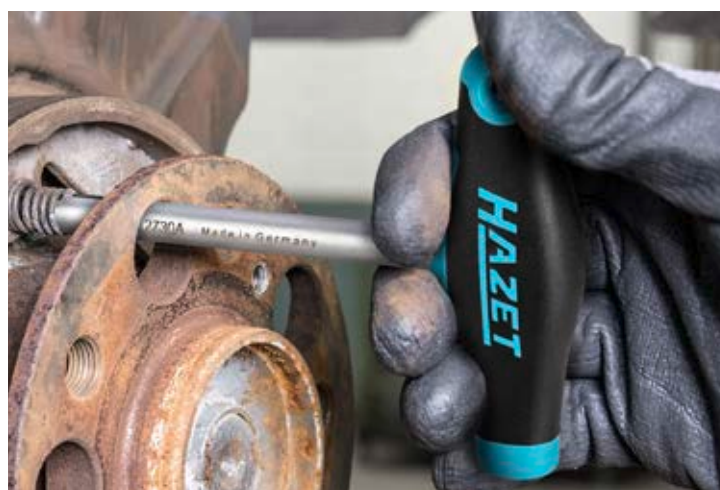



CLASSICS – REDISCOVERED!

Cylinder head tightness tester

- Detecting cylinder head gasket defects, leaks between the combustion chamber and the cooling system
- For water-cooled combustion engines (gas, diesel and petrol)
- Supplied in plastic box 165-L

Contents:

- Tester 4793-1
- Reaction fluid (250 ml) 4793-2
- Flushing fluid (250 ml) 4793-3



Made in Germany

4793/3

EAN-No. 4000896076192



3

Nut splitter, mechanical

- Splitting tight nuts of the quality ranges 5 and 6
- For nuts M10 – M16
- Wrench size 17 – 24 mm



Made in Germany

847-1027A

EAN-No. 4000896139910



Stethoscope

- Locating defective parts e.g. axles, bearings and gearbox
- Diaphragm with efficient transmission rate
- Steel tip: 180 mm
- Length: 1,080 mm



2151

EAN-No. 4000896013043



Hose clamp pliers

- Clamping range: 35 mm
- Length: 206 mm



Made in Germany
798-3
EAN-No. 4000896102433



- Clamping range: 40 mm
- Length: 210 mm



Made in Germany
798-5
EAN-No. 4000896031955



- Clamping range: 27 mm
- Length: 192 mm

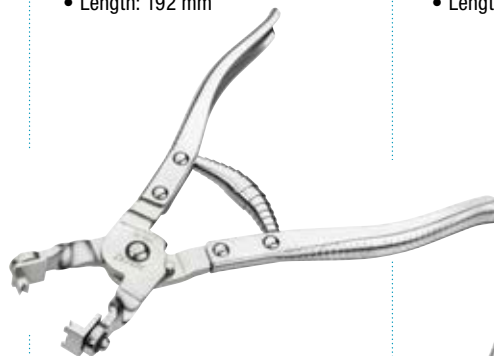

Made in Germany
798-13
EAN-No. 4000896155248



- Clamping range: 40 mm
- Length: 210 mm

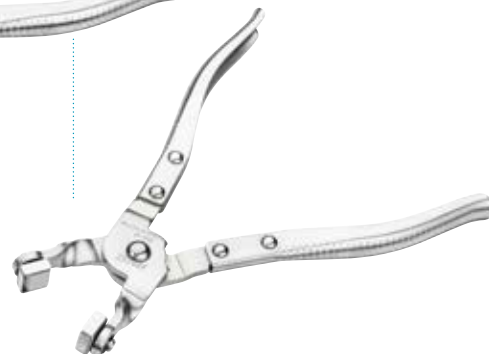

Made in Germany
798-17
EAN-No. 4000896186068



Engine

Exhaust pipe clamp pliers

- For quick opening and holding open of the reusable exhaust pipe clamps as well as for removal and installation
- The bolt and nut of the exhaust pipe clamp can remain in the clamp during work on the exhaust system thanks to the pliers design
- Application e.g. on: CITROËN, PEUGEOT · DS · RENAULT · NISSAN, OPEL · ALFA ROMEO · FIAT · JEEP · CADILLAC · LANCIA · SUZUKI, CHEVROLET · BMW · MERCEDES-BENZ · LAND ROVER · FORD · DACIA · NISSAN · Volvo · MAZDA
- Toothed fixing device and one-hand operation
- Fixing device is released by pressure lever
- Pliers tips enable secure hold of the clamp
- Length: 310 mm
- Clamping range: 50 mm

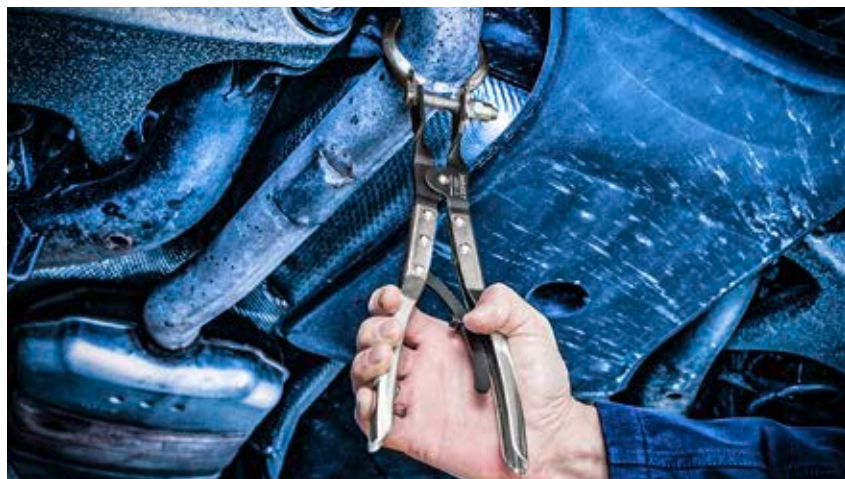

Made in Germany
4684-3
EAN-No. 4000896189205





HAZET PORSCHE TOOL TROLLEY EDITION ...

PORSCHE
MOTORSPORT

OFFICIAL SUPPLIER
HAZET

LIMITED EDITION

NEW!

100 pieces each including assortment!

HAZET Porsche Motorsport tool trolley edition with 321 expert tools

- 7 drawers (40 kg loading capacity per drawer, 100% sliding-out)
- Elastic castors enable smooth movement
- Including door on the right and locks with simultaneous locking
- Soft foam inserts in special black and white Porsche colour scheme!

AUGMENTED REALITY

Assistent[®]

179NXL-7

Design: **black**
including assortment

179NXL-7BPORSCHE

EAN-No. 4000896254002



AUGMENTED REALITY

Assistent[®]

179NXL-7

Design: **white**
including assortment

179NXL-7WPORSCHE

EAN-No. 4000896253982



HAZET TOOL INSERTS IN PORSCHE COLOUR SCHEME WITH HIPER FINE-TOOTH REVERSIBLE RATCHET

Including 1/2" HiPer torque wrench
6122-1CT · 40 – 200 Nm

- ±2 %, length: 547 mm



S 17 mm

S 19 mm

S 21 mm

Including 1/2" impact socket set,
hexagon 903SPC/3



Including 1/2" HiPer fine-tooth
reversible ratchet 916HP · 1,000 Nm

- In gold-coloured TiN-coated special version

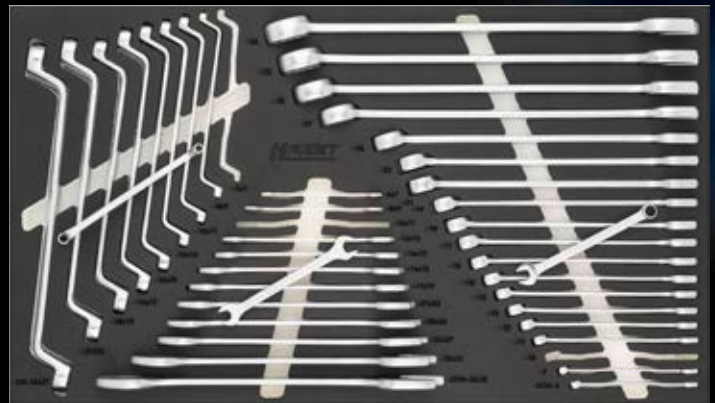
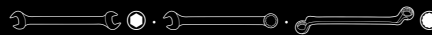

Each insert is only included once in the assortment.





TOOLS FOR WINNER ONLY!

LIMITED EDITION



OFFICIAL SUPPLIER

PORSCHE
MOTORSPORT



Your HAZET specialist dealer



SWW2324/EN/XX/0 | 08.2023/1.75 JK/MD

HAZET-WERK Hermann Zerver GmbH & Co KG · Gldenwerther Bahnhofstrae 25 – 29 · D-42857 Remscheid · Germany
We accept no liability for printing errors! All rights reserved regarding technical modifications and errors, images may not always correspond to originals and are thus non-binding! Copyright 2023 ©