



# Bits & Sockets

Product Catalogue



  
**BiX** co.,LTD.

# Screwdriver bits

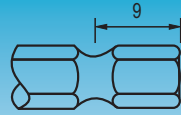

MODEL **B-15** 6.35mm

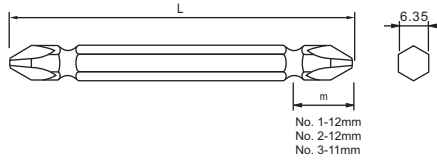
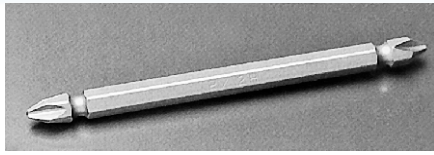

EDP #	POINT SIZE	(d x L1)	Shaft diameter	L	Equivalent to	
					Vessel	Ohmi
B15150	No.1			50	B-43	V-17W
B15175				75		
B151100				100		
B15250	No.2		H6.35	50		
B15275				75		
B152100				100		
B152150				150		
B152200				200		
B152250				※250		
B152300				※300		
B15350	No.3			50		
B15375				75		
B153100				100		

※shows non-standard products

MODEL **B-35** 6.35mm

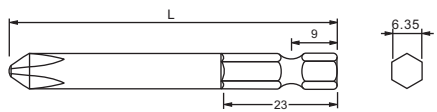
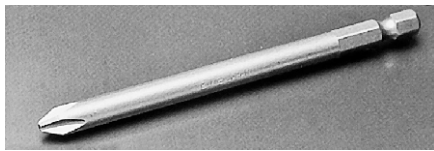

EDP #	POINT SIZE	(d x L1)	Shaft diameter	L	Equivalent to	
					Vessel	Ohmi
B35150	No.1			50	B-35	V-17
B35175				75		
B351100				100		
B351150	※150					
B35250	No.2		φ7	50		
B35275				75		
B352100				100		
B352150				150		
B352200	※200					
B35375	No.3			75		
B353100				100		
B353150				150		
B353200				※200		

※shows non-standard products

MODEL **B-35M** 6.35mm

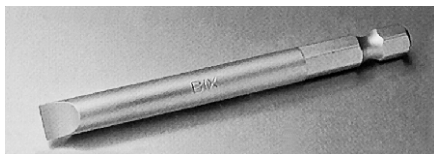

EDP #	POINT SIZE	(d x L1)	Shaft diameter	L	Equivalent to	
					Vessel	Ohmi
B35M7075	-0.9tx7		φ7	75	B-35	V-17M
B35M70100				100		

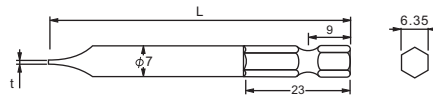

MODEL **B-35D** 6.35mm

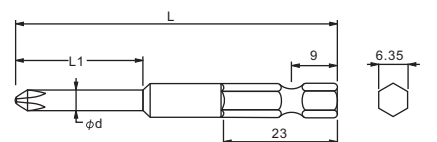

EDP #	POINT SIZE	(d x L1)	Shaft diameter	L	Equivalent to	
					Vessel	Ohmi
B35D075	No.0			75	B-35	V-17
B35D0100				100		
B35D175	No.1	φ4.0X30	φ7	75		
B35D1100				100		
B35D275	No.2			75		
B35D2100				100		



# Screwdriver bits

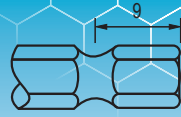

**BiX**

**MODEL B-35HS** 6.35mm

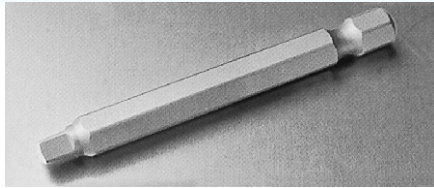

EDP #	POINT SIZE	(d x L1)	Shaft diameter	L	Equivalent to	
					Vessel	Ohmi
B35HS175	(SQ1)		H6.35	75		
B35HS1100	3/32"			100		
B35HS275	(SQ2)			75		
B35HS2100	1/8"			100		
B35HS375	(SQ3)			75		
B35HS3100	9/64"			100		

**MODEL B-35X** 6.35mm

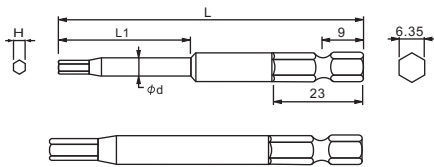
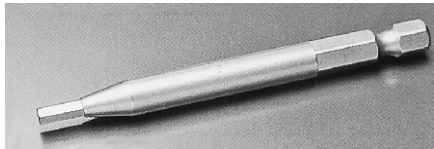

EDP #	POINT SIZE	(d x L1)	Shaft diameter	L	Equivalent to	
					Vessel	Ohmi
B35X1575	H1.5	φ 3.0X30	φ 7	75	B-35	
B35X15100				100		
B35X2075	H2	φ 4.0X30		75		
B35X20100				100		
B35X2575	H2.5			75		
B35X25100				100		
B35X3075	H3		75			
B35X30100			100			
B35X4075	H4		75			
B35X40100			100			
B35X5075	H5		75			
B35X50100			100			
B35X6075	H6		75			
B35X60100			100			

**MODEL B-35H** 6.35mm



EDP #	POINT SIZE	(d x L1)	Shaft diameter	L	Equivalent to	
					Vessel	Ohmi
B35H130	No.1		H6.35	30	B-39	
B35H150				50		
B35H175				75		
B35H230	No.2			30		
B35H250				50		
B35H275				75		
B35H330	No.3	30				
B35H350		50				
B35H375		75				

# Screwdriver bits



MODEL **B-35HD** 6.35mm

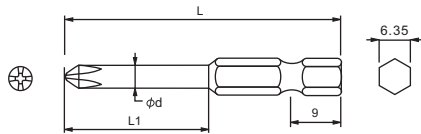
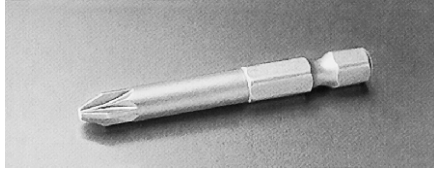
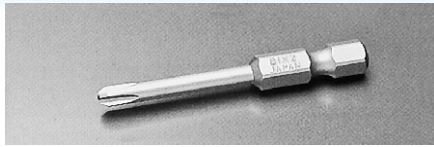

EDP #	POINT SIZE	(d x L 1)	Shaft diameter	L	Equivalent to	
					Vessel	Ohmi
B35HD050	No. 0	φ 3.8 X 28	H6.35	50	B-35	
B35HD150	No. 1			50		
B35HD250	No. 2			50		
35HDPZ14850	PZ1	φ 4.8 X 28		50		
35HDPZ14870		φ 4.8 X 50		75		
35HDPZ14890		φ 4.8 X 70		100		
35HDPZ26050	PZ2	φ 6.0 X 28		50		
35HDPZ26070		φ 6.0 X 50		75		
35HDPZ26090		φ 6.0 X 70		100		
35HDPZ36050	PZ3	φ 6.0 X 28		50		
35HDPZ36070		φ 6.0 X 50	75			
35HDPZ36090		φ 6.0 X 70	100			

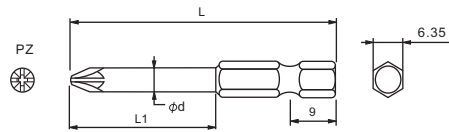

MODEL **B-35HDM** 6.35mm

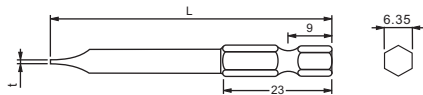

EDP #	POINT SIZE	(d x L 1)	Shaft diameter	L	Equivalent to	
					Vessel	Ohmi
B35HDM3850	-0.6tx3.8	φ 3.8 X 28	H6.35	50	B-35	
B35HDM6050	-0.8tx6	φ 6.0 X 28		50		
B35HDM6075	-0.8tx6	φ 6.0 X 50		75		
B35HDM60100	-0.8tx6	φ 6.0 X 70		100		

Double-grooved type (for B-35 and B39)

MODEL **B-37X** 6.35mm

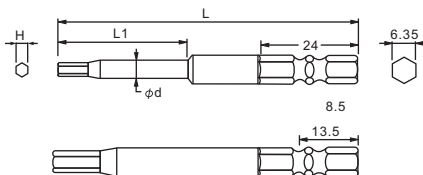

EDP #	POINT SIZE	(d x L 1)	Shaft diameter	L	Equivalent to	
					Vessel	Ohmi
B37X1570	H1.5	φ 3.0 X 30	φ 7	70	V-32X	
B37X15100				100		
B37X2070	H2	φ 4.0 X 30		70		
B37X20100				100		
B37X2570	H2.5			70		
B37X25100				100		
B37X3070				70		
B37X30100	H3			100		
B37X4070	H4			70		
B37X40100				100		
B37X5070	H5			70		
B37X50100				100		
B37X6070			70			
B37X60100	H6		100			



# Screwdriver bits

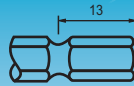

**BiX**

MODEL **B-12** 6.35mm

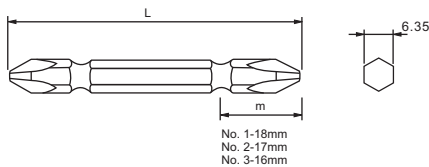
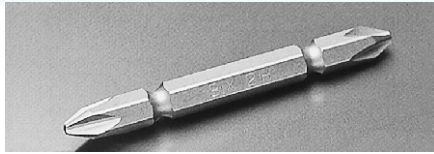

EDP #	POINT SIZE	(d x L1)	Shaft diameter	L	Equivalent to	
					Vessel	Ohmi
B12145	No.1		H6.35	45	A-14	V-21W
B12165				65		
B12175				※75		
B121110				110		
B121150				150		
B121200	200					
B12245	No.2		H6.35	45		
B12265				65		
B12275				※75		
B122110				110		
B122150				150		
B122200	200					
B122250	※250					
B122300	※300					
B12365	No.3		H6.35	65		
B12375				75		
B123110				※110		
B123150				150		
B123200				200		
				※		

※shows non-standard products

MODEL **B-39D** 6.35mm

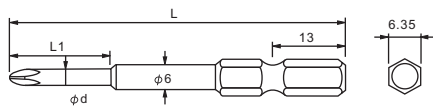

EDP #	POINT SIZE	(d x L1)	Shaft diameter	L	Equivalent to	
					Vessel	Ohmi
B39D075D	No.0	φ 3.0 X 30	H6.35	75	D-81	V-21
B39D175D	No.1					
B39D275D	No.2					
B39D182	No.1	φ 5.0 X 35	H6.35	82		
B39D282	No.2					
B39D175	No.1	φ 6	H6.35	75		
B39D275	No.2					

MODEL **B-39M** 6.35mm

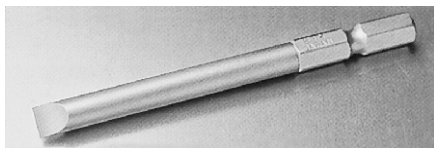

EDP #	POINT SIZE	(d x L1)	Shaft diameter	L	Equivalent to	
					Vessel	Ohmi
B39M6075	-0.8x6	φ 6	H6.35	75	A-16	V-21M
B39M8075	-1.0x8	φ 8	H6.35	※75		

※shows non-standard products



MODEL **B-39X** 6.35mm

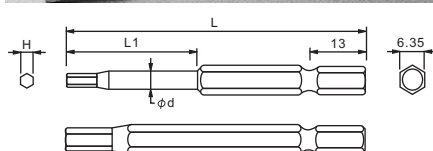
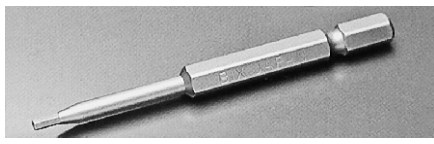

EDP #	POINT SIZE	(d x L1)	Shaft diameter	L	Equivalent to	
					Vessel	Ohmi
B39X2075	H2	φ 4.0 X 30	H6.35	75	A-16	
B39X20100				100		
B39X2575	H2.5		H6.35	75		
B39X25100				100		
B39X3075	H3		H6.35	75		
B39X30100				100		
B39X4075	H4		H6.35	75		
B39X40100				100		
B39X5075	H5		H6.35	75		
B39X50100				100		
B39X6075	H6		H6.35	75		
B39X60100				100		

# Screwdriver bits

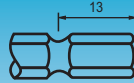

MODEL **B-39S** 6.35mm

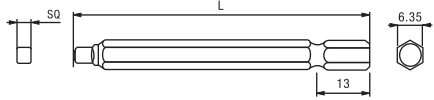
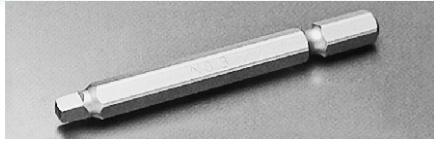

EDP #	POINT SIZE	(d x L 1)	Shaft diameter	L	Equivalent to	
					Vessel	Ohmi
B39S175	(SQ1)		H6.35	75	A-16	
B39S1100	3/32"			100		
B39S275	(SQ2)			75		
B39S2100	1/8"			100		
B39S375	(SQ3)			75		
B39S3100	9/64"			100		

MODEL **B-52** 6.35mm

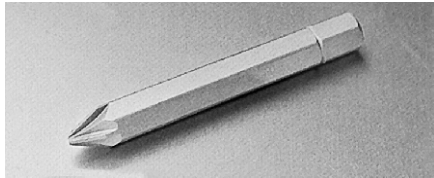

EDP #	POINT SIZE	(d x L 1)	Shaft diameter	L	Equivalent to	
					Vessel	Ohmi
B52125	No.1		H6.35	25	B-33	V-27
B52150				50		
B52225				25		
B52250	No.2			50		
B52325				25		
B52350	No.3			50		
B52PZ125			25			
B52PZ150	PZ1		50			
B52PZ225			25			
B52PZ250	PZ2		50			
B52PZ325			25			
B52PZ350	PZ3		50			
			50			

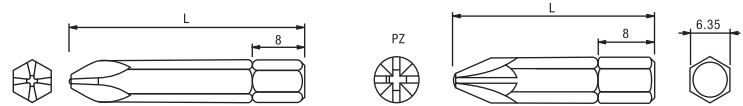

MODEL **B-52M** 6.35mm

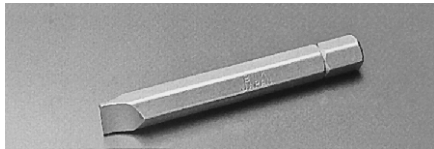

EDP #	POINT SIZE	(d x L 1)	Shaft diameter	L	Equivalent to	
					Vessel	Ohmi
B52M6350	-0.8tx6.3		H6.35	50	B-33	V-27

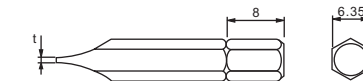

## Bit holders B-52, B-52M

with magnet

MODEL **B-35MH** 6.35mm



EDP #	POINT SIZE	(d x L 1)	Shaft diameter	L	Equivalent to	
					Vessel	Ohmi
B35MH6375	H6.35	φ 11	H6.35	75	HBM	

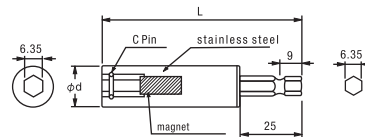

with magnet

MODEL **B-39MH** 6.35mm



EDP #	POINT SIZE	(d x L 1)	Shaft diameter	L	Equivalent to	
					Vessel	Ohmi
B39MH6375	H6.35	φ 11	H6.35	75	HAM	

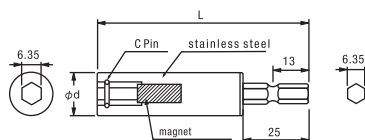

# Screwdriver bits // (Hex lobe)



## Cordless driver bit

MODEL	<b>B-52C</b>	6.35mm	
-------	--------------	--------	--

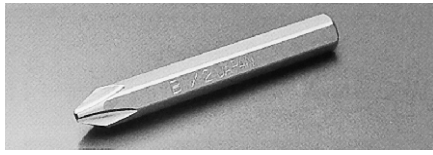

EDP #	POINT SIZE	(d x L1)	Shaft diameter	L	Equivalent to	
					Vessel	Ohmi
B52C150	No.1		H6.35	50	D-85	
B52C250	No.2			50		
B52CM6350	-1.0tx6.3			50		

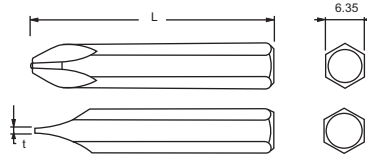

MODEL	<b>B-15T</b>	6.35mm	
-------	--------------	--------	--

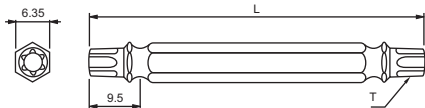
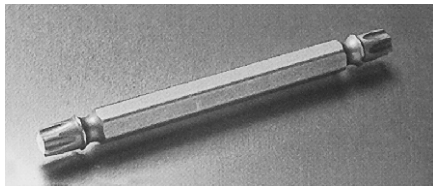

EDP #	POINT SIZE	(d x L1)	Shaft diameter	L	Equivalent to	
					Vessel	Ohmi
B15T2075	T20		H6.35	75	JT	V-17T
B15T20100				100		
B15T2575	T25		H6.35	75		
B15T25100				100		
B15T3075	T30		H6.35	75		
B15T30100				100		
B15T4075	T40		H6.35	75		
B15T40100				100		

MODEL	<b>B-35T</b>	6.35mm	
-------	--------------	--------	--

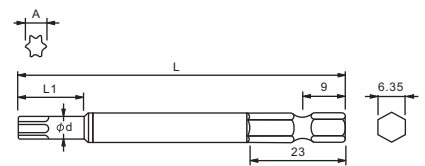
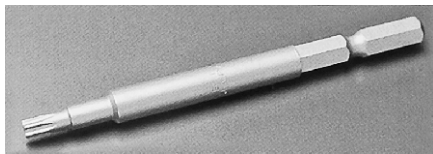

EDP #	POINT SIZE	(d x L1)	Shaft diameter	L	Equivalent to	
					Vessel	Ohmi
B35T0875	T8	φ 3.0 X 15	φ 7	75	JT	V-17T
B35T08100				100		
B35T1075	T10	φ 3.6 X 15		75		
B35T10100				100		
B35T1575	T15	φ 4.3 X 15		75		
B35T15100				100		
B35T2075	T20	φ 5.0 X 15		75		
B35T20100				100		
B35T2575	T25	φ 5.5 X 15		75		
B35T25100				100		
B35T2775	T27	φ 6.0 X 15		75		
B35T27100				100		
B35T3075	T30	φ 6.5 X 15	75			
B35T30100			100			
B35T4075	T40	φ 7.0	75			
B35T40100			100			

MODEL	<b>B-35HT</b>	6.35mm	
-------	---------------	--------	--

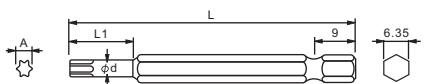
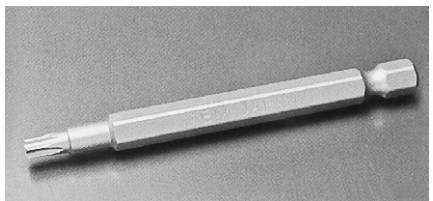

EDP #	POINT SIZE	(d x L1)	Shaft diameter	L	Equivalent to	
					Vessel	Ohmi
B35HT0875	T8	φ 3.0 X 15	φ 7	75	JT	V-17T
B35HT08100				100		
B35HT1075	T10	φ 3.6 X 15		75		
B35HT10100				100		
B35HT1575	T15	φ 4.3 X 15		75		
B35HT15100				100		
B35HT2075	T20	φ 5.0 X 15		75		
B35HT20100				100		
B35HT2575	T25	φ 5.5 X 15		75		
B35HT25100				100		
B35HT2775	T27	φ 6.0 X 15		75		
B35HT27100				100		
B35HT3075	T30	φ 6.0 X 15	75			
B35HT30100			100			
B35HT4075	T40		75			
B35HT40100			100			



# Screwdriver bits // (Hex lobe)

MODEL	<b>B-39T</b>	6.35mm 
-------	--------------	--

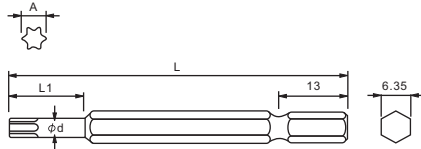
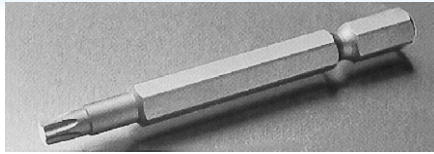

EDP #	POINT SIZE	(d x L 1)	Shaft diameter	L	Equivalent to	
					Vessel	Ohmi
B39T0865	T8	φ 3.0 X 15	H6.35	65	VT	V-21T
B39T08110				110		
B39T1065				65		
B39T10110	110					
B39T1565	T10	φ 3.6 X 15		65		
B39T15110				110		
B39T2065	T15	φ 4.3 X 15		65		
B39T20110				110		
B39T2565	T20	φ 5.0 X 15		65		
B39T25110				110		
B39T2765	T25	φ 5.5 X 15		65		
B39T27110				110		
B39T3065	T27	φ 6.0 X 15		65		
B39T30110				110		
B39T4065	T30			65		
B39T40110			110			
B39T4065	T40		65			
B39T40110			110			

※ Tamper resistance available upon request.



Available in India From :

**SUMITRON EXPORTS PVT. LTD.**

An ISO 9001:2008 Certified Company

**Head Office :**

27, Community Centre, Naraina,  
Phase-I, New Delhi-110 028 India  
Phone : 91-11-41410631 / 41410632 / 41410633  
41410634 / 41410635; Fax : 91-11-41410494  
E-mail : sumitron@vsnl.com; sumitron@airtelmail.in  
Website: <http://www.sumitron.com>

**Delhi Sales Office :**

F-19/1, Opp. M2K, Sector-8, Rohini, Delhi-110 085  
Phone : 91-11-43824444 (6 lines)  
E-mail : contact@sumitron.com



**Branch Offices:**

**Bangalore:** Phone : 91-80-22223593 / 22228178 / 41125584  
Fax : 91-80-22244783; Mobile : +91-98861-29125  
E-mail : bangalore.sumitron@airtelmail.in  
**Chennai:** Phone : 044-42876727; Fax : 044-22418525  
Mobile : +91-98402-21470; E-mail : sumitronche@airtelmail.in  
**Mumbai:** Phone : 022-67983237; Fax : 022-25779522  
Mobile : +91-98200-32828; E-mail : sumitron@eth.net  
**Pune:** 020-64599077 / 30460766; Fax : 020-41314989  
Mobile : +91-98900-07525; E-mail : pune@sumitron.com  
**Kolkata:** Mobile : +91-98310-68327  
E-mail : sumitronkolkata@gmail.com  
**Hyderabad:** Mobile : +91-89857-64655  
**Haridwar:** Resident Rep. : Mobile : +91-97209-37576

**BIX co.,LTD.**

1040 Heiwacho, Izumi City,  
Kagoshima PREF 899-0217 JAPAN  
TEL 0996-63-0067 FAX 0996-63-3309  
URL:<http://www.5.ocn.ne.jp/~bix/>  
E-Mail:bix@vesta.ocn.ne.jp

※ Please provide your full Postal Address, Telephone / Fax Nos. in all your E-mail Messages.

# Small electric driver bits

## 小型電動ドライバー用ビット

MODEL	<b>BD-4</b>	4mm $\ominus$
-------	-------------	---------------

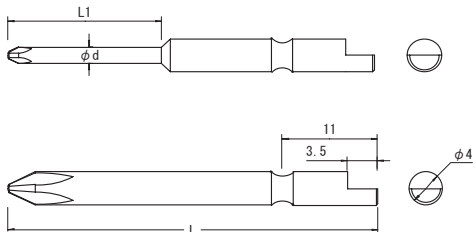

EDP #	POINT SIZE	(d x L1)	Shank diameter	L	Equivalent to		
					Vessel	Ohmi	
BD4001244	No.00	$\phi 1.2 \times 20$	$\phi 4$	44	D-71	V-05	
BD4001264		$\phi 1.2 \times 20$		64			
BD4001444		$\phi 1.4 \times 20$		44			
BD4001464		$\phi 1.4 \times 20$		64			
BD4001544		$\phi 1.5 \times 20$		44			
BD4001564		$\phi 1.5 \times 20$		64			
BD4001744		$\phi 1.7 \times 20$		44			
BD4001764		$\phi 1.7 \times 20$		64			
BD4001844		$\ast \phi 1.8 \times 20$		44			
BD4001864		$\ast \phi 1.8 \times 20$		64			
BD4002044		$\phi 2.0 \times 20$		44			
BD4002064		$\phi 2.0 \times 20$		64			
BD401444		No.0		$\phi 1.4 \times 20$			44
BD401464				$\phi 1.4 \times 20$			64
BD401544				$\phi 1.5 \times 20$			44
BD401564				$\phi 1.5 \times 20$			64
BD401744	$\phi 1.7 \times 20$		44				
BD401764	$\phi 1.7 \times 20$		64				
BD401844	$\ast \phi 1.8 \times 20$		44				
BD401864	$\ast \phi 1.8 \times 20$		64				
BD402044	$\phi 2.0 \times 20$		44				
BD402064	$\phi 2.0 \times 20$		64				
BD402344	$\ast \phi 2.3 \times 20$		44				
BD402364	$\ast \phi 2.3 \times 20$		64				
BD402544	$\phi 2.5 \times 20$		44				
BD402564	$\phi 2.5 \times 20$		64				
BD403044	$\phi 3.0 \times 20$		44				
BD403064	$\phi 3.0 \times 20$		64				
BD404044	$\phi 4.0$	44					
BD404064	$\phi 4.0$	64					
BD412544	No.1	$\phi 2.5 \times 20$	44				
BD412564		$\phi 2.5 \times 20$	64				
BD413044		$\phi 3.0 \times 20$	44				
BD413064		$\phi 3.0 \times 20$	64				
BD414044		$\phi 4.0$	44				
BD414064		$\phi 4.0$	64				
BD424044	No.2	$\phi 4.0$	44				
BD424064		$\phi 4.0$	64				

(No.00 follows our in-house standards)  
(No.00については当社規格です。)

$\ast$  shows non-standard products

$\ast$ 印は標準品です。

$\ast$ We can also manufacture products longer than 80mm total length.

$\ast$ 全長80mm以上についても製作致します

# Small electric driver bits

**BiX**

## 小型電動ドライバー用ビット

小型電動ドライバービット

MODEL **BD-4M** 4mm

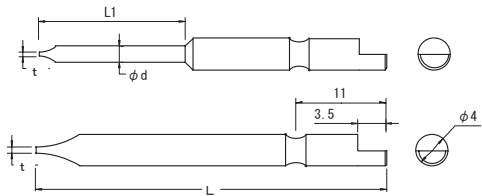

EDP #	POINT SIZE	(d × L1)	Shank diameter	L	Equivalent to	
					Vessel	Ohmi
BD4M2044	-0.4t×2.0	φ 2.0×20	φ 4	44	D-71	V-05M
BD4M2064		φ 2.0×20		64		
BD4M2544		φ 2.5×20		44		
BD4M2564	-0.4t×2.5	φ 2.5×20		64		
BD4M3044		φ 3.0×20		44		
BD4M3064		φ 3.0×20		64		
BD4M4044	-0.6t×4.0	φ 4.0×20		44		
BD4M4064		φ 4.0×20		64		
BD4M4064		φ 4.0×20		64		

MODEL **BD-4X** 4mm

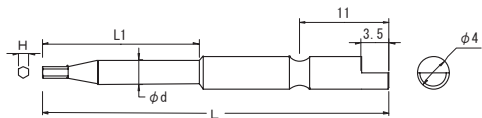

EDP #	POINT SIZE	(d × L1)	Shank diameter	L	Equivalent to	
					Vessel	Ohmi
BD4X1544	H1.5	φ 3.0×20	φ 4	44	D-71	V-05X
BD4X1564		φ 3.0×20		64		
BD4X2044	H2.0	φ 3.0×20		44		
BD4X2064		φ 3.0×20		64		
BD4X2544	H2.5	φ 3.0×20		44		
BD4X2564		φ 3.0×20		64		
BD4X3044	H3	φ 4.0		44		
BD4X3064		φ 4.0		64		
BD4X4044	H4	φ 5.0		※44		
BD4X4064		φ 5.0	※64			

※shows non-standard products

※印は標準品です。

※We can also manufacture products longer than 80mm total length.

※全長80mm以上についても製作致します

MODEL **BH-4V** 4mm

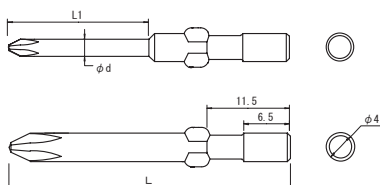

EDP #	POINT SIZE	(d × L1)	Shank diameter	L	Equivalent to		
					Vessel	HIOS	
B4V001240	No.00	φ 1.2×20	φ 4	40	D-73	BP-H4	
B4V001260		φ 1.2×20		60			
B4V001540		φ 1.5×20		40			
B4V001560		φ 1.5×20		60			
B4V001740		φ 1.7×20		40			
B4V001760		φ 1.7×20		60			
B4V002040		φ 2.0×20		40			
B4V002060		φ 2.0×20		60			
B4V002080		φ 2.0×20		80			
B4V002080-3		φ 2.0×30		80			
B4V01440		No.0		φ 1.4×20			40
B4V01460				φ 1.4×20			60
B4V01480	φ 1.4×20		80				
B4V014100	φ 1.4×20		100				
B4V01480-3	φ 1.4×30		80				
B4V014100-3	φ 1.4×30		100				



# Small electric driver bits

## 小型電動ドライバー用ビット

MODEL	<b>BH-4V</b>	4mm◆
-------	--------------	------

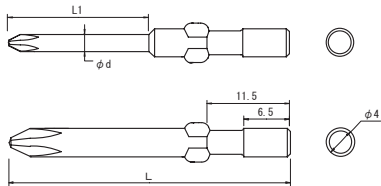

EDP #	POINT SIZE	(d × L1)	Shank diameter	L	Equivalent to		
					Vessel	HIOS	
B4V01540	No.0	φ 1.5 × 20	φ 4	40	D-73	BP-H4	
B4V01560		φ 1.5 × 20		60			
B4V01740		φ 1.7 × 20		40			
B4V01760		φ 1.7 × 20		60			
B4V01780		φ 1.7 × 20		80			
B4V01780-3		φ 1.7 × 30		80			
B4V02040		φ 2.0 × 20		40			
B4V02060		φ 2.0 × 20		60			
B4V02080		φ 2.0 × 20		80			
B4V020100		φ 2.0 × 20		100			
B4V02080-3		φ 2.0 × 30		80			
B4V020100-3		φ 2.0 × 30		100			
B4V02340		※ φ 2.3 × 20		40			
B4V02360		※ φ 2.3 × 20		60			
B4V02540		φ 2.5 × 20		40			
B4V02560		φ 2.5 × 20		60			
B4V02580		φ 2.5 × 20		80			
B4V025100		φ 2.5 × 20		100			
B4V02580-3		φ 2.5 × 30		80			
B4V025100-3		φ 2.5 × 30		100			
B4V03040		φ 3.0 × 20		40			
B4V03060		φ 3.0 × 20		60			
B4V03080		φ 3.0 × 20		80			
B4V030100		φ 3.0 × 20		100			
B4V03080-3		φ 3.0 × 30		80			
B4V030100-3		φ 3.0 × 30		100			
B4V04040		φ 4.0		40			
B4V04060		φ 4.0		60			
B4V12040		No.1		φ 2.0 × 20			40
B4V12060				φ 2.0 × 20			60
B4V12540				φ 2.5 × 20			40
B4V12560				φ 2.5 × 20			60
B4V12580				φ 2.5 × 20			80
B4V125100				φ 2.5 × 20			100
B4V12580-3				φ 2.5 × 30			80
B4V125100-3				φ 2.5 × 30			100
B4V13040				φ 3.0 × 20			40
B4V13060				φ 3.0 × 20			60
B4V13080				φ 3.0 × 20			80
B4V130100				φ 3.0 × 20			100
B4V13080-3	φ 3.0 × 30		80				
B4V130100-3	φ 3.0 × 30		100				
B4V14040	φ 4.0		40				
B4V14060	φ 4.0		60				
B4V14080	φ 4.0		80				
B4V140100	φ 4.0		100				
B4V140120	φ 4.0		120				
B4V24040	No.2		φ 4.0	40			
B4V24060		φ 4.0	60				
B4V24080		φ 4.0	80				
B4V240100		φ 4.0	100				
B4V240120		φ 4.0	120				

(No.00 follows our in-house standards)  
(No.00については当社規格です。)

※shows non-standard products

※印は準標準品です。

※We can also manufacture products longer than 80mm total length.

※全長80mm以上についても製作致します

# Small electric driver bits

**BiX**

## 小型電動ドライバー用ビット

小型電動ドライバービット

MODEL **BH-4VM** 4mm

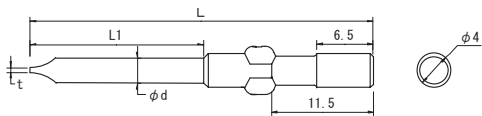

EDP #	POINT SIZE	(d × L1)	Shank diameter	L	Equivalent to	
					Vessel	HIOS
B4VM1140	-0.28t×1.1	φ 1.1 × 20	φ 4	40	D-73	BS-H4
B4VM1160		φ 1.1 × 20		60		
B4VM1340	-0.28t×1.3	φ 1.3 × 20		40		
B4VM1360		φ 1.3 × 20		60		
B4VM1540	-0.3t×1.5	φ 1.5 × 20		40		
B4VM1560		φ 1.5 × 20		60		
B4VM1740	-0.3t×1.7	φ 1.7 × 20		40		
B4VM1760		φ 1.7 × 20		60		
B4VM2040	-0.4t×2.0	φ 2.0 × 20		40		
B4VM2060		φ 2.0 × 20		60		
B4VM2080	-0.4t×2.3	φ 2.0 × 20		80		
B4VM2340		φ 2.3 × 20		40		
B4VM2360	φ 2.3 × 20	60				
B4VM2540	-0.4t×2.5	φ 2.5 × 20		40		
B4VM2560		φ 2.5 × 20		60		
B4VM2580	-0.4t×3.0	φ 2.5 × 20		80		
B4VM3040		φ 3.0 × 20		40		
B4VM3060	φ 3.0 × 20	60				
B4VM3080	φ 3.0 × 20	80				
B4VM4040	-0.6t×4.0	φ 4.0		40		
B4VM4060		φ 4.0	60			
B4VM4080		φ 4.0	80			

MODEL **BH-4VX** 4mm

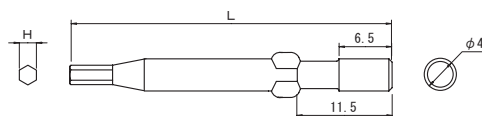
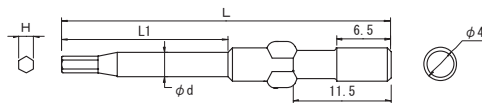

EDP #	POINT SIZE	(d × L1)	Shank diameter	L	Equivalent to	
					Vessel	HIOS
B4VX1540	H1.5	φ 3.0 × 20	φ 4	40	D-73	BH-H4
B4VX1560		φ 3.0 × 20		60		
B4VX2040	H2.0	φ 3.0 × 20		40		
B4VX2060		φ 3.0 × 20		60		
B4VX2540	H2.5	φ 3.0 × 20		40		
B4VX2560		φ 3.0 × 20		60		
B4VX3040	H3	φ 4		40		
B4VX3060		φ 4		60		
B4VX4040	H4	φ 5.0		40		
B4VX4060		φ 5.0		60		

※shows non-standard products  
※印は標準品です。

# Small electric driver bits

## 小型電動ドライバー用ビット

MODEL **BH-5V** 5mm

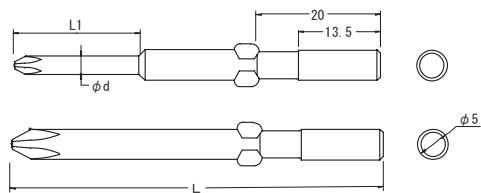

EDP #	POINT SIZE	(d × L1)	Shank diameter	L	Equivalent to		
					Vessel	HIOS	
B5V02060	No.0	φ 2.0 × 20	φ 5	60	D-76	BP-H5	
B5V02080		φ 2.0 × 20		80			
B5V02560		φ 2.5 × 20		60			
B5V02580		φ 2.5 × 20		80			
B5V03060		φ 3.0 × 20		60			
B5V03080		φ 3.0 × 20		80			
B5V05060		φ 5.0		60			
B5V05080		φ 5.0		80			
B5V13060		No.1		φ 3.0 × 20			60
B5V13080				φ 3.0 × 20			80
B5V13060-3	φ 3.0 × 30		60				
B5V13080-3	φ 3.0 × 30		80				
B5V15060	φ 5.0		60				
B5V15080	φ 5.0	80					
B5V150100	φ 5.0	100					
B5V25060	No.2	φ 5.0	60				
B5V25080		φ 5.0	80				
B5V250100		φ 5.0	100				
B5V250120		φ 5.0	120				

MODEL **BH-5VM** 5mm

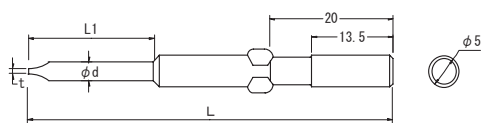

EDP #	POINT SIZE	(d × L1)	Shank diameter	L	Equivalent to	
					Vessel	HIOS
B5VM2060	-0.4t×2.0	φ 2.0 × 20	φ 5	60	D-76	BS-H5
B5VM2080		φ 2.0 × 20		80		
B5VM2560	-0.4t×2.5	φ 2.5 × 20	φ 5	60	D-76	BS-H5
B5VM2580		φ 2.5 × 20		80		
B5VM3060	-0.4t×3.0	φ 3.0 × 20	φ 5	60	D-76	BS-H5
B5VM3080		φ 3.0 × 20		80		
B5VM4060	-0.6t×4.0	φ 4.0 × 20	φ 5	60	D-76	BS-H5
B5VM4080		φ 4.0 × 20		80		
B5VM5060	-0.6t×5.0	φ 5.0 × 20	φ 5	60	D-76	BS-H5
B5VM5080		φ 5.0 × 20		80		



# Small electric driver bits

**BiX**

## 小型電動ドライバー用ビット

小型電動ドライバービット

MODEL **BH-5VX** 5mm

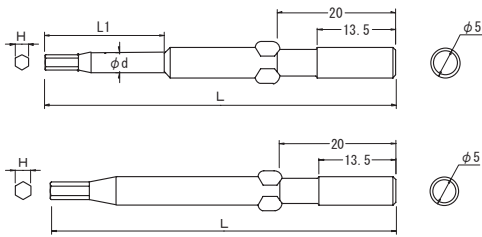

EDP #	POINT SIZE	(d x L1)	Shank diameter	L	Equivalent to	
					Vessel	HIOS
B5VX1560	H1.5	φ 3.0 x 20	φ 5	60	D-76	BH-H5
B5VX1580		φ 3.0 x 20		80		
B5VX2060	H2.0	φ 3.0 x 20		60		
B5VX2080		φ 3.0 x 20		80		
B5VX2560	H2.5	φ 3.0 x 20		60		
B5VX2580		φ 3.0 x 20		80		
B5VX3060	H3	φ 4.0 x 20		60		
B5VX3080		φ 4.0 x 20		80		
B5VX4060	H4	φ 5		60		
B5VX4080		φ 5		80		
B5VX5060	H5	φ 6.0		※60		
B5VX5080		φ 6.0		※80		

※shows non-standard products

※印は準標準品です。

※We can also manufacture products longer than 80mm total length.

※全長80mm以上についても製作致します

MODEL **B-10** 3mm

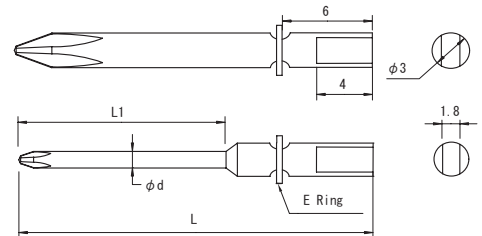

EDP #	POINT SIZE	(d x L1)	Shank diameter	L	Equivalent to	
					Vessel	Ohmi
B10020(L)	No.0	φ 2.0 x 15	φ 3	31 · 36 · 50	A-7	V-01
B10025(L)		φ 2.5 x 15		31 · 36 · 50		
B10030(L)		φ 3		31 · 36 · 50		
B10120(L)	No.1	φ 2.0 x 15		31 · 36 · 50		
B10125(L)		φ 2.5 x 15		31 · 36 · 50		
B10130(L)		φ 3		31 · 36 · 50		

(Please inquire about above models before ordering.)

(このモデルはその都度お問い合わせください。)

MODEL **B-10M** 3mm



EDP #	POINT SIZE	(d x L1)	Shank diameter	L	Equivalent to	
					Vessel	Ohmi
B10M30(L)	-0.35t x 3	φ 3	φ 3	21 · 40	A-7	V-01M

(Please inquire about above models before ordering.)

(このモデルはその都度お問い合わせください。)

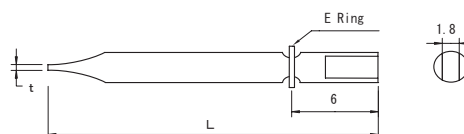

# Small electric driver bits(Hex lobe)

## 小型電動ドライバー用ビット「ヘックスローブ」

MODEL **BD-4T** 4mm

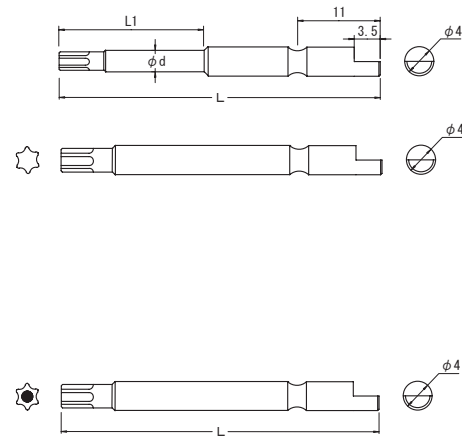

Tamper resistant (H)  
いじり止め付き (H)

EDP #	POINT SIZE	(d × L1)	Shank diameter	L	Equivalent to	
					Vessel	Ohmi
BD4T144	T1	φ 1.3×15	φ 4	44	D-71	V-05T
BD4T164		φ 1.3×15		64		
BD4T244	T2	φ 1.5×15		44		
BD4T264		φ 1.5×15		64		
BD4T344	T3	φ 1.7×20		44		
BD4T364		φ 1.7×20		64		
BD4T444	T4	φ 1.8×20		44		
BD4T464		φ 1.8×20		64		
BD4T544	T5	φ 2.0×20		44		
BD4T564		φ 2.0×20		64		
BD4T644	T6	φ 2.0×20		44		
BD4T664		φ 2.0×20		64		
BD4T844	T8	φ 2.5×20		44		
BD4T864		φ 2.5×20		64		
BD4T1044	T10	φ 3.0×20		44		
BD4T1064		φ 3.0×20	64			
BD4T1544	T15	φ 4.0	44			
BD4T1564		φ 4.0	64			
BD4T8H44	T8H	φ 2.5×20	44			
BD4T8H64		φ 2.5×20	64			
BD4T10H44	T10H	φ 3.0×20	44			
BD4T10H64		φ 3.0×20	64			
BD4T15H44	T15H	φ 4.0	44			
BD4T15H64		φ 4.0	64			

MODEL **BH-4VT** 4mm

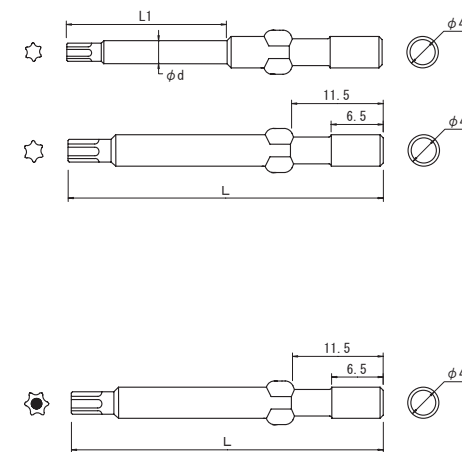

Tamper resistant (H)  
いじり止め付き (H)

EDP #	POINT SIZE	(d × L1)	Shank diameter	L	Equivalent to	
					Vessel	HIOS
B4VT140	T1	φ 1.3×15	φ 4	40	D-73	H4
B4VT160		φ 1.3×15		60		
B4VT240	T2	φ 1.5×15		40		
B4VT260		φ 1.5×15		60		
B4VT340	T3	φ 1.7×20		40		
B4VT360		φ 1.7×20		60		
B4VT440	T4	φ 1.8×20		40		
B4VT460		φ 1.8×20		60		
B4VT540	T5	φ 2.0×20		40		
B4VT560		φ 2.0×20		60		
B4VT640	T6	φ 2.0×20		40		
B4VT660		φ 2.0×20		60		
B4VT840	T8	φ 2.5×20		40		
B4VT860		φ 2.5×20		60		
B4VT1040	T10	φ 3.0×20		40		
B4VT1060		φ 3.0×20	60			
B4VT1540	T15	φ 4.0	40			
B4VT1560		φ 4.0	60			
B4VT8H40	T8H	φ 2.5×20	40			
B4VT8H60		φ 2.5×20	60			
B4VT10H40	T10H	φ 3.0×20	40			
B4VT10H60		φ 3.0×20	60			
B4VT15H40	T15H	φ 4.0	40			
B4VT15H60		φ 4.0	60			

# Small electric driver bits(Hex lobe)

**BiX**

## 小型電動ドライバー用ビット「ヘックスローブ」

MODEL **BH-5VT** 5mm

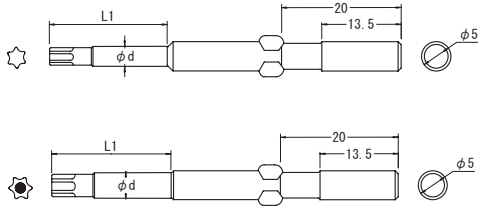

Tamper resistant (H)  
いじり止め付き (H)

EDP #	POINT SIZE	(d × L1)	Shank diameter	L	Equivalent to	
					Vessel	HIOS
B5VT560	T5	φ 2.0 × 20	φ 5	60	D-76	H5
B5VT580		φ 2.0 × 20		80		
B5VT660	T6	φ 2.5 × 20		60		
B5VT680		φ 2.5 × 20		80		
B5VT860	T8	φ 3.0 × 20		60		
B5VT880		φ 3.0 × 20		80		
B5VT1060	T10	φ 3.0 × 20		60		
B5VT1080		φ 3.0 × 20		80		
B5VT1560	T15	φ 4.0 × 20		60		
B5VT1580		φ 4.0 × 20		80		
B5VT8H60	T8H	φ 3.0 × 20		60		
B5VT8H80		φ 3.0 × 20		80		
B5VT10H60	T10H	φ 3.0 × 20	60			
B5VT10H80		φ 3.0 × 20	80			
B5VT15H60	T15H	φ 4.0 × 20	60			
B5VT15H80		φ 4.0 × 20	80			

※We can also manufacture products longer than 80mm total length.  
※全長80mm以上についても製作致します

小型電動ドライバービット

# Small electric driver socket bits

## 小型電動ドライバー用ソケットビット

MODEL **BD-4B** 4mm

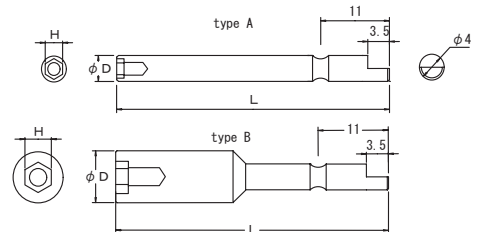

EDP #	Hex opening(H)	O/D	L	Type
4DB2344	2.3	4	44	A
4DB2364	2.3	4	64	A
4DB2544	2.5	4	44	A
4DB2564	2.5	4	64	A
4DB0344	3	5	44	B
4DB0364	3	5	64	B
4DB0444	4	6	44	B
4DB0464	4	6	64	B
4DB4544	4.5	7	44	B
4DB4564	4.5	7	64	B
4DB0544	5	7	44	B
4DB0564	5	7	64	B
4DB5544	5.5	8	44	B
4DB5564	5.5	8	64	B

# Small electric driver bits(Hex lobe)

**BiX**

## 小型電動ドライバー用ビット「ヘックスローブ」

MODEL **BH-5VT** 5mm

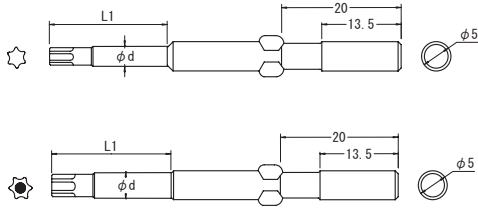

Tamper resistant (H)  
いじり止め付き (H)

EDP #	POINT SIZE	(d × L1)	Shank diameter	L	Equivalent to	
					Vessel	HIOS
B5VT560	T5	φ 2.0 × 20	φ 5	60	D-76	H5
B5VT580		φ 2.0 × 20		80		
B5VT660	T6	φ 2.5 × 20		60		
B5VT680		φ 2.5 × 20		80		
B5VT860	T8	φ 3.0 × 20		60		
B5VT880		φ 3.0 × 20		80		
B5VT1060	T10	φ 3.0 × 20		60		
B5VT1080		φ 3.0 × 20		80		
B5VT1560	T15	φ 4.0 × 20		60		
B5VT1580		φ 4.0 × 20		80		
B5VT8H60	T8H	φ 3.0 × 20		60		
B5VT8H80		φ 3.0 × 20		80		
B5VT10H60	T10H	φ 3.0 × 20	60			
B5VT10H80		φ 3.0 × 20	80			
B5VT15H60	T15H	φ 4.0 × 20	60			
B5VT15H80		φ 4.0 × 20	80			

※We can also manufacture products longer than 80mm total length.  
※全長80mm以上についても製作致します

小型電動ドライバービット

# Small electric driver socket bits

## 小型電動ドライバー用ソケットビット

MODEL **BD-4B** 4mm

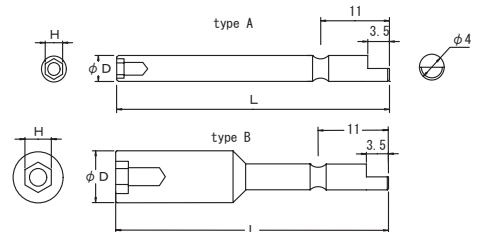

EDP #	Hex opening(H)	O/D	L	Type
4DB2344	2.3	4	44	A
4DB2364	2.3	4	64	A
4DB2544	2.5	4	44	A
4DB2564	2.5	4	64	A
4DB0344	3	5	44	B
4DB0364	3	5	64	B
4DB0444	4	6	44	B
4DB0464	4	6	64	B
4DB4544	4.5	7	44	B
4DB4564	4.5	7	64	B
4DB0544	5	7	44	B
4DB0564	5	7	64	B
4DB5544	5.5	8	44	B
4DB5564	5.5	8	64	B



# Small electric driver socket bits

## 小型電動ドライバー用ソケットビット

MODEL **BD-4BM** 4mm◆

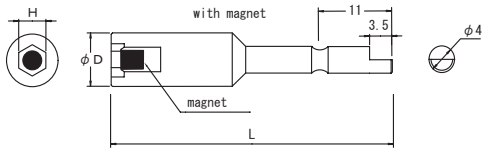

EDP #	Hex opening(H)	O/D	L	Type
4DBM0464	4	6	64	With Mg
4DBM0564	5	7	64	With Mg
4DBM5564	5.5	8	64	With Mg

MODEL **BH-4VB** 4mm◆

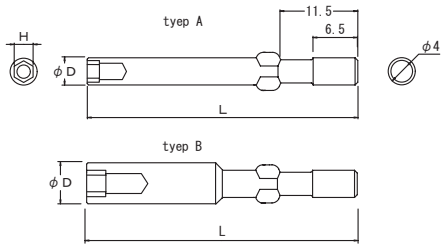

EDP #	Hex opening(H)	O/D	L	Type
4VB2340	2.3	4	40	A(φ4)
4VB2540	2.5	4	40	A(φ4)
4VB0360	3	5	60	B(φ4)
4VB0460	4	6	60	B(φ4)
4VB4560	4.5	7	60	B(φ4)
4VB0560	5	7	60	B(φ4)
4VB5560	5.5	8	60	B(φ4)

MODEL **BH-4VBM** 4mm◆

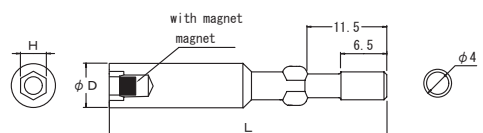

EDP #	Hex opening(H)	O/D	L	Type
4VBM0460	4	6	60	With Mg
4VBM0560	5	7	60	With Mg
4VBM5560	5.5	8	60	With Mg

# Small electric driver socket bits

**BiX**

## 小型電動ドライバー用ソケットビット

MODEL **BH-5VB** 5mm◆

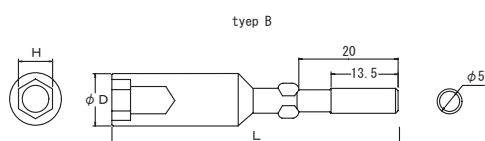

EDP #	Hex opening(H)	O/D	L	Type
5VB0460	4	7	60	B(φ5)
5VB4560	4.5	7	60	B(φ5)
5VB0560	5	8	60	B(φ5)
5VB5560	5.5	9	60	B(φ5)
5VB0660	6	10	60	B(φ5)
5VB0760	7	11	60	B(φ5)

MODEL **BH-5VBM** 5mm◆

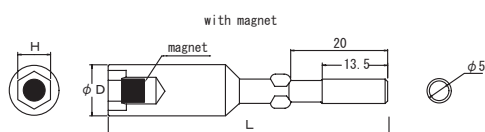

EDP #	Hex opening(H)	O/D	L	Type
5VBM0460	4	7	60	With Mg
5VBM0560	5	8	60	With Mg
5VBM5560	5.5	9	60	With Mg
5VBM0660	6	10	60	With Mg
5VBM0760	7	11	60	With Mg

※We can also manufacture tailor-made products based on your drawings and samples.

※図面、サンプル等により特殊品の製作も承ります。

小型電動ドライバービット

# Screwdriver bits

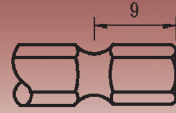

## ドライバービット

MODEL **B-15** 6.35mm

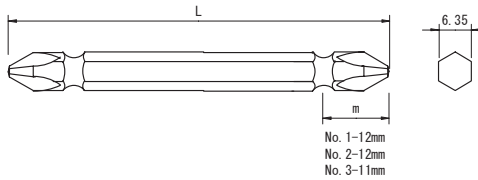

EDP #	POINT SIZE	(d × L1)	Shank diameter	L	Equivalent to	
					Vessel	Ohmi
B15150	No.1			50	B-43	V-17W
B15175				75		
B151100				100		
B15250	No.2		H6.35	50	B-43	V-17W
B15275				75		
B152100				100		
B152150				150		
B152200				200		
B152250				※250		
B152300	※300					
B15350	No.3			50		
B15375				75		
B153100				100		

※shows non-standard products  
※印は標準品です。

MODEL **B-35** 6.35mm

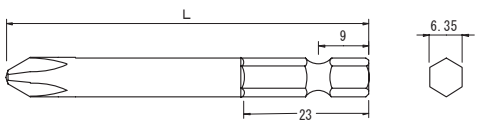

EDP #	POINT SIZE	(d × L1)	Shank diameter	L	Equivalent to	
					Vessel	Ohmi
B35150	No.1			50	B-35	V-17
B35175				75		
B351100				100		
B351150				※150		
B35250	No.2		φ7	50	B-35	V-17
B35275				75		
B352100				100		
B352150				150		
B352200				※200		
B35375				75		
B353100	No.3			100		
B353150				150		
B353200				※200		

※shows non-standard products  
※印は標準品です。

MODEL **B-35M** 6.35mm

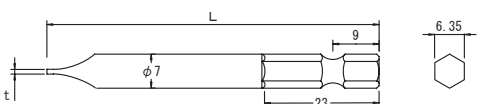

EDP #	POINT SIZE	(d × L1)	Shank diameter	L	Equivalent to	
					Vessel	Ohmi
B35M7075	-0.9t×7		φ7	75	B-35	V-17M
B35M70100				100		

# Screwdriver bits



**BiX**

## ドライバービット

MODEL **B-35D** 6.35mm

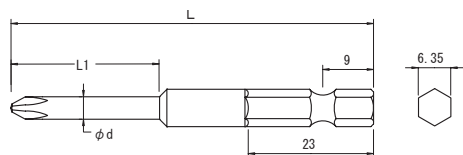

EDP #	POINT SIZE	(d × L1)	Shank diameter	L	Equivalent to	
					Vessel	Ohmi
B35D075	No.0	φ4.0×30	φ7	75	B-35	V-17
B35D0100				100		
B35D175	No.1			75		
B35D1100				100		
B35D275	No.2			75		
B35D2100				100		

MODEL **B-35HS** 6.35mm

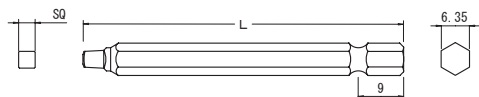

EDP #	POINT SIZE	(d × L1)	Shank diameter	L	Equivalent to	
					Vessel	Ohmi
B35HS175	(SQ1)		H6.35	75		
B35HS1100	3/32"			100		
B35HS275	(SQ2)			75		
B35HS2100	1/8"			100		
B35HS375	(SQ3)			75		
B35HS3100	9/64"			100		

MODEL **B-35X** 6.35mm

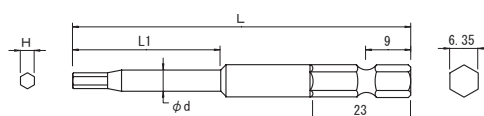

EDP #	POINT SIZE	(d × L1)	Shank diameter	L	Equivalent to	
					Vessel	Ohmi
B35X1575	H1.5	φ3.0×30	φ7	75	B-35	
B35X15100				100		
B35X2075	H2	φ4.0×30		75		
B35X20100				100		
B35X2575	H2.5			75		
B35X25100				100		
B35X3075	H3			75		
B35X30100				100		
B35X4075	H4			75		
B35X40100				100		
B35X5075	H5			75		
B35X50100				100		
B35X6075	H6			75		
B35X60100				100		

ドライバービット



# Screwdriver bits

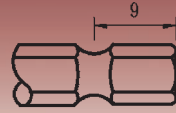

## ドライバービット

MODEL **B-35H** 6.35mm

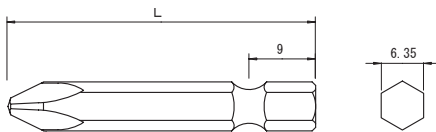

EDP #	POINT SIZE	(d × L1)	Shank diameter	L	Equivalent to					
					Vessel	Ohmi				
B35H130	No.1		H6.35	30	B-39					
B35H150				50						
B35H175				75						
B35H230	No.2		H6.35	30			B-39			
B35H250				50						
B35H275				75						
B35H330	No.3		H6.35	30					B-39	
B35H350				50						
B35H375				75						

MODEL **B-35HD** 6.35mm

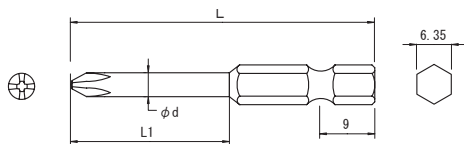

EDP #	POINT SIZE	(d × L1)	Shank diameter	L	Equivalent to					
					Vessel	Ohmi				
B35HD050	No.0	φ3.8×28	H6.35	50	B-35					
B35HD150	No.1			50						
B35HD250	No.2			50						
35HDPZ14850	PZ1	φ4.8×28		50			B-35			
35HDPZ14870		φ4.8×50		70						
35HDPZ14890		φ4.8×70		90						
35HDPZ26050	PZ2	φ6.0×28		50					B-35	
35HDPZ26070		φ6.0×50		70						
35HDPZ26090		φ6.0×70		90						
35HDPZ36050	PZ3	φ6.0×28	50	B-35						
35HDPZ36070		φ6.0×50	70							
35HDPZ36090		φ6.0×70	90							

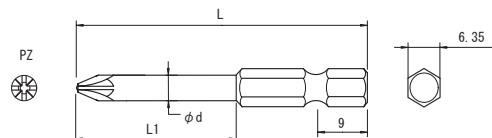

MODEL **B-35HDM** 6.35mm

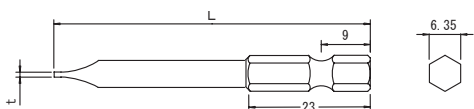

EDP #	POINT SIZE	(d × L1)	Shank diameter	L	Equivalent to	
					Vessel	Ohmi
B35HDM3850	-0.6t×3.8	φ3.8×28	H6.35	50	B-35	
B35HDM6050	-0.8t×6	φ6.0×28		50		
B35HDM6075	-0.8t×6	φ6.0×50		75		
B35HDM60100	-0.8t×6	φ6.0×70		100		

# Screwdriver bits

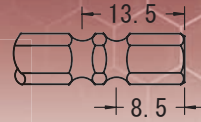

**BiX**

## ドライバービット

Double-grooved type (for B-35 and B39)

MODEL **B-37X** 6.35mm

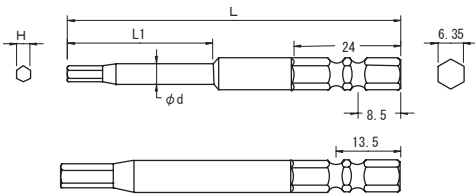

EDP #	POINT SIZE	(d × L1)	Shank diameter	L	Equivalent to	
					Vessel	Ohmi
B37X1570	H1.5	φ 3.0 × 30	φ 7	70		V-32X
B37X15100				100		
B37X2070				H2		
B37X20100	100					
B37X2570	H2.5			70		
B37X25100				100		
B37X3070	H3			70		
B37X30100				100		
B37X4070	H4			70		
B37X40100				100		
B37X5070	H5			70		
B37X50100				100		
B37X6070	H6			70		
B37X60100				100		

ドライバービット

# Screwdriver bits



## ドライバービット

MODEL **B-12** 6.35mm

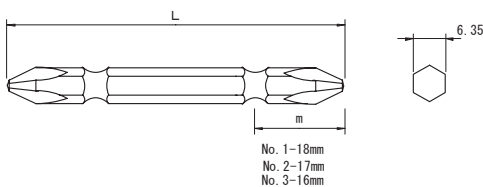

EDP #	POINT SIZE	(d × L1)	Shank diameter	L	Equivalent to	
					Vessel	Ohmi
B12145	No.1		H6.35	45	A-14	V-21W
B12165				65		
B12175				※75		
B121110				110		
B121150				150		
B121200				200		
B12245	No.2			45		
B12265				65		
B12275				※75		
B122110				110		
B122150				150		
B122200				200		
B122250	※250					
B122300	※300					
B12365	No.3			65		
B12375				※75		
B123110				110		
B123150				150		
B123200			※200			

※shows non-standard products  
※印は標準品です。

# Screwdriver bits

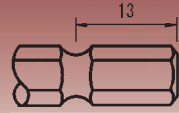

## ドライバービット

MODEL **B-39D** 6.35mm

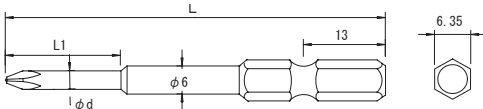

EDP #	POINT SIZE	(d × L1)	Shank diameter	L	Equivalent to	
					Vessel	Ohmi
B39D075D	No.0	φ3.0×30	H6.35	75	D-81	V-21
B39D175D	No.1					
B39D275D	No.2					
B39D182	No.1	φ5.0×35		82		
B39D282	No.2					
B39D175	No.1	φ6		75		
B39D275	No.2					

MODEL **B-39M** 6.35mm



EDP #	POINT SIZE	(d × L1)	Shank diameter	L	Equivalent to	
					Vessel	Ohmi
B39M6075	-0.8t×6	φ6	H6.35	75	A-16	V-21M
B39M8075	-1.0t×8	φ8		※75		



※shows non-standard products  
※印は準標準品です。

MODEL **B-39X** 6.35mm

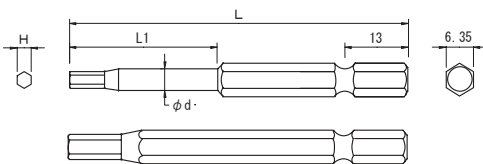

EDP #	POINT SIZE	(d × L1)	Shank diameter	L	Equivalent to	
					Vessel	Ohmi
B39X2075	H2	φ4.0×30	H6.35	75	A-16	
B39X20100				100		
B39X2575	H2.5			75		
B39X25100				100		
B39X3075	H3			75		
B39X30100				100		
B39X4075	H4		75			
B39X40100			100			
B39X5075	H5		75			
B39X50100			100			
B39X6075	H6		75			
B39X60100			100			

MODEL **B-39S** 6.35mm

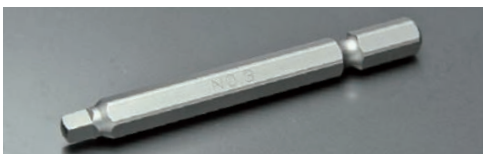

EDP #	POINT SIZE	(d × L1)	Shank diameter	L	Equivalent to	
					Vessel	Ohmi
B39S165	(SQ1)		H6.35	65	A-16	
B39S1110	3/32"			110		
B39S265	(SQ2)			65		
B39S2110	1/8"			110		
B39S365	(SQ3)			65		
B39S3110	9/64"			110		

# Screwdriver bits

## ドライバービット

MODEL **B-52** 6.35mm



EDP #	POINT SIZE	(d × L1)	Shank diameter	L	Equivalent to	
					Vessel	Ohmi
B52125	No.1		H6.35	25	B-33	V-27
B52150				50		
B52225	No.2		H6.35	25		
B52250				50		
B52325	No.3		H6.35	25		
B52350				50		
B52PZ125	PZ1		H6.35	25		
B52PZ150				50		
B52PZ225	PZ2		H6.35	25		
B52PZ250				50		
B52PZ325	PZ3		H6.35	25		
B52PZ350				50		



ドライバービット

MODEL **B-52M** 6.35mm



EDP #	POINT SIZE	(d × L1)	Shank diameter	L	Equivalent to	
					Vessel	Ohmi
B52M6350	-0.8t×6.3		H6.35	50	B-33	V-27

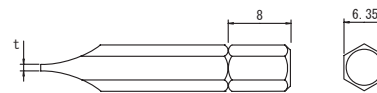

## Bit holders B-52、B-52M 用ビットホルダー

with magnet

MODEL **B-35MH** 6.35mm



EDP #	POINT SIZE	(d × L1)	Shank diameter	L	Equivalent to	
					Vessel	Ohmi
B35MH6375	H6.35	φ 11	H6.35	75	HBM	

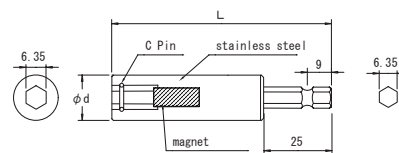

with magnet

MODEL **B-39MH** 6.35mm



EDP #	POINT SIZE	(d × L1)	Shank diameter	L	Equivalent to	
					Vessel	Ohmi
B39MH6375	H6.35	φ 11	H6.35	75	HAM	

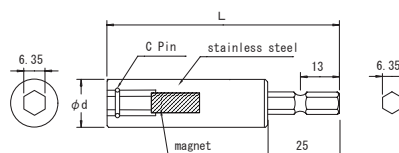



# Screwdriver bits

## ドライバービット

### Cordless driver bit

MODEL	<b>B-52C</b>	6.35mm
-------	--------------	--------



EDP #	POINT SIZE	(d × L1)	Shank diameter	L	Equivalent to	
					Vessel	Ohmi
B52C150	No.1		H6.35	50	D-85	
B52C250	No.2			50		
B52CM6350	-1.0t×6.3			50		

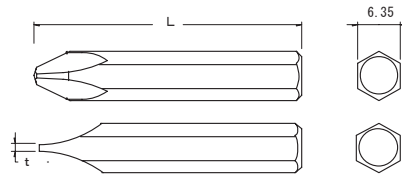

MODEL	<b>B-13</b>	8mm
-------	-------------	-----

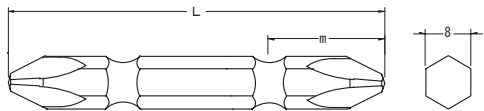

EDP #	POINT SIZE	(d × L1)	Shank diameter	L	Equivalent to	
					Vessel	Ohmi
B13265	No.2		H8	65	A-15	V-24W
B132100	(m=20)			100		
B13365	No.3			65		
B133100	(m=19)			100		

### Impact type

MODEL	<b>B-51</b>	8mm
-------	-------------	-----

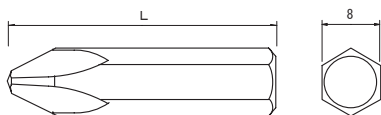

EDP #	POINT SIZE	(d × L1)	Shank diameter	L	Equivalent to	
					Vessel	Ohmi
B51236	No.2		H8	36	C-51	V-23
B51280				80		
B51336	No.3			36		
B51380				80		

# Screwdriver bits

**BiX**

## ドライバービット

MODEL **B-51M** 8mm

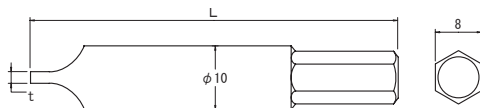

EDP #	POINT SIZE	(d × L1)	Shank diameter	L	Equivalent to	
					Vessel	Ohmi
B51M1080	-1.2t×10		φ 10	80	C-51	

MODEL **B-16** 5mm

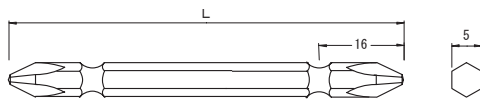

EDP #	POINT SIZE	(d × L1)	Shank diameter	L	Equivalent to						
					Vessel	Ohmi					
B16050	No.0			※50	B-36	V-14W					
B16070				70							
B160100				100							
B160120				120							
B160150				※150							
B160200				※200							
B16150	No.1		H5	※50	B-36	V-14W					
B16170				70							
B161100				100							
B161120				120							
B161150				150							
B161200				※200							
B161250				※250							
B161300				※300							
B16250				No.2					※50	B-36	V-14W
B16270									70		
B162100	100										
B162120	120										
B162150	150										
B162200	200										
B162250	※250										
B162300	※300										

※shows non-standard products  
※印は標準品です。

ドライバービット

# Screwdriver bits

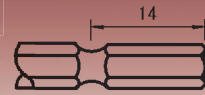

## ドライバービット

MODEL **B-31** 5mm

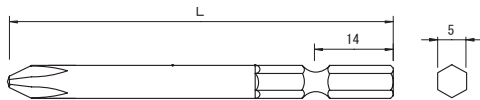

EDP #	POINT SIZE	(d × L1)	Shank diameter	L	Equivalent to	
					Vessel	Ohmi
B31050	No.0			※50	B-34	V-14
B31070				70		
B310100				100		
B310120				120		
B310150				※150		
B310200				※200		
B31150	No.1		φ6	※50	B-34	V-14
B31170				70		
B311100				100		
B311120				120		
B311150				150		
B311200				※200		
B311250				※250		
B311300				※300		
B31250	No.2			※50		
B31270				70		
B312100				100		
B312120				120		
B312150				150		
B312200				200		
B312250				※250		
B312300				※300		

※shows non-standard products  
※印は標準品です。

MODEL **B-31M** 5mm

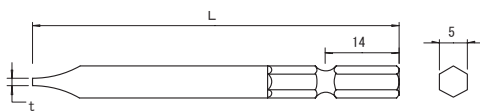

EDP #	POINT SIZE	(d × L1)	Shank diameter	L	Equivalent to	
					Vessel	Ohmi
B31M6050	-0.8t×6		φ6	※50	B-34	V-14M
B31M6070				70		
B31M60100				100		

※shows non-standard products  
※印は標準品です。

# Screwdriver bits

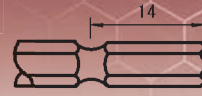

**BiX**

## ドライバービット

MODEL **B-31D** 5mm◆

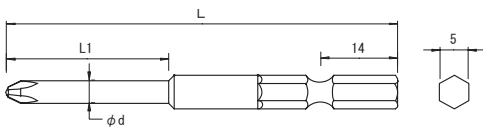

EDP #	POINT SIZE	(d × L1)	Shank diameter	L	Equivalent to	
					Vessel	Ohmi
B31D070	No.0	φ 3.0 × 30	φ 6	70	B-34	V-14
B31D0100				100		
B31D170	No.1	φ 4.0 × 30		70		
B31D1100				100		
B31D270	No.2	φ 4.0 × 30		70		
B31D2100				100		
B31D2120			120			

MODEL **B-31X** 5mm◆

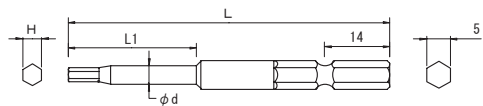

EDP #	POINT SIZE	(d × L1)	Shank diameter	L	Equivalent to	
					Vessel	Ohmi
B31X1570	H1.5	φ 3.0 × 30	φ 6	70	B-34	V-14X
B31X15100				100		
B31X2070	H2	φ 4.0 × 30		70		
B31X20100				100		
B31X2570	H2.5			70		
B31X25100				100		
B31X3070	H3		70			
B31X30100			100			
B31X4070	H4		70			
B31X40100			100			
B31X5070	H5		H5	70		
B31X50100			100			

ドライバービット



# Screwdriver bits (Hex lobe)

## ドライバービット [ヘックスローブ]

MODEL **B-15T** 6.35mm

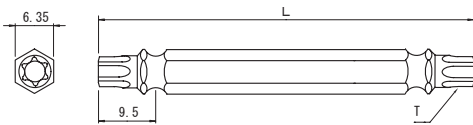
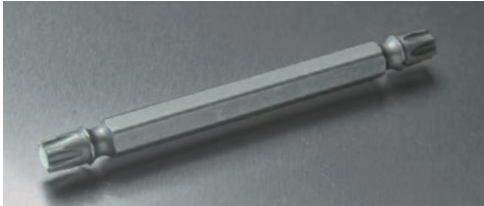

EDP #	POINT SIZE	(d × L1)	Shank diameter	L	Equivalent to	
					Vessel	Ohmi
B15T2075	T20		H6.35	75	JT	V-17T
B15T20100				100		
B15T2575	T25		H6.35	75		
B15T25100				100		
B15T3075	T30		H6.35	75		
B15T30100				100		
B15T4075	T40		H6.35	75		
B15T40100				100		

MODEL **B-31T** 5mm

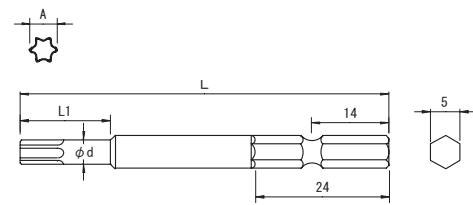

EDP #	POINT SIZE	(d × L1)	Shank diameter	L	Equivalent to	
					Vessel	Ohmi
B31T0575	T5	φ2.0×15	φ6	75	NT	V-14T
B31T05100				100		
B31T0675	T6	φ2.5×15		75		
B31T06100				100		
B31T0875	T8	φ3.0×15		75		
B31T08100				100		
B31T1075	T10	φ3.6×15		75		
B31T10100				100		
B31T1575	T15	φ4.3×15		75		
B31T15100				100		
B31T2075	T20	φ5.0×15		75		
B31T20100				100		
B31T2575	T25	φ5.5×15		75		
B31T25100				100		

# Screwdriver bits (Hex lobe)

**BiX**

ドライバービット [ヘックスローブ]

MODEL **B-35T** 6.35mm

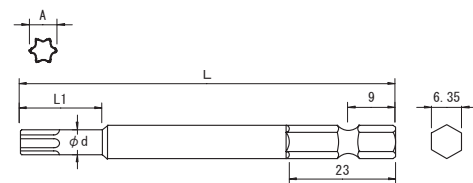

EDP #	POINT SIZE	(d × L1)	Shank diameter	L	Equivalent to	
					Vessel	Ohmi
B35T0875	T8	φ3.0×15	φ7	75	JT	V-17T
B35T08100				100		
B35T1075	T10	φ3.6×15		75		
B35T10100				100		
B35T1575	T15	φ4.3×15		75		
B35T15100				100		
B35T2075	T20	φ5.0×15		75		
B35T20100				100		
B35T2575	T25	φ5.5×15		75		
B35T25100				100		
B35T2775	T27	φ6.0×15		75		
B35T27100				100		
B35T3075	T30	φ6.5×15		75		
B35T30100				100		
B35T4075	T40	φ7.0		75		
B35T40100				100		

ドライバービット

MODEL **B-35HT** 6.35mm

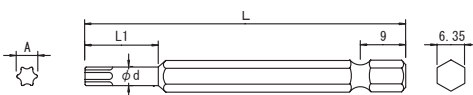

EDP #	POINT SIZE	(d × L1)	Shank diameter	L	Equivalent to	
					Vessel	Ohmi
B35HT0875	T8	φ3.0×15	φ7	75	JT	V-17T
B35HT08100				100		
B35HT1075	T10	φ3.6×15		75		
B35HT10100				100		
B35HT1575	T15	φ4.3×15		75		
B35HT15100				100		
B35HT2075	T20	φ5.0×15		75		
B35HT20100				100		
B35HT2575	T25	φ5.5×15		75		
B35HT25100				100		
B35HT2775	T27	φ6.0×15		75		
B35HT27100				100		
B35HT3075	T30	φ6.0×15		75		
B35HT30100				100		
B35HT4075	T40			75		
B35HT40100				100		

# Screwdriver bits (Hex lobe)

## ドライバービット [ヘックスローブ]

MODEL **B-39T** 6.35mm

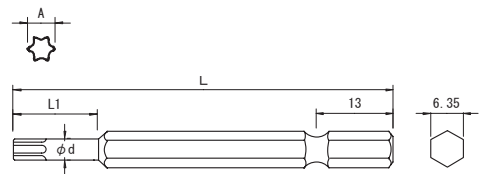
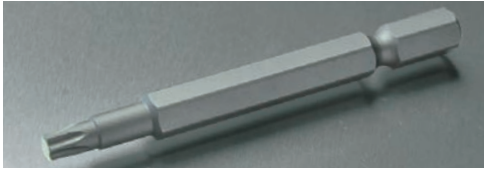

EDP #	POINT SIZE	(d × L1)	Shank diameter	L	Equivalent to	
					Vessel	Ohmi
B39T0865	T8	φ3.0×15	H6.35	65	VT	V-21T
B39T08110				110		
B39T1065	T10	φ3.6×15		65		
B39T10110				110		
B39T1565	T15	φ4.3×15		65		
B39T15110				110		
B39T2065	T20	φ5.0×15		65		
B39T20110				110		
B39T2565	T25	φ5.5×15		65		
B39T25110				110		
B39T2765	T27	φ6.0×15		65		
B39T27110				110		
B39T3065	T30		65			
B39T30110			110			
B39T4065	T40		65			
B39T40110			110			

※ Tamper resistance available upon request.  
 ※ ご希望に応じジリ止め付きについても対応致します。

MODEL **B-51T** 8mm

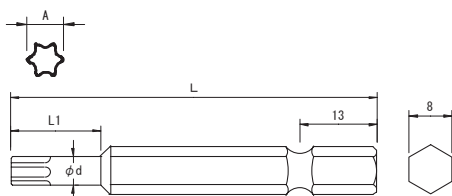
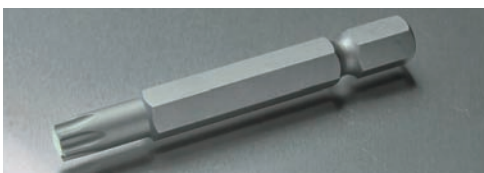

EDP #	POINT SIZE	(d × L1)	Shank diameter	L	Equivalent to	
					Vessel	Ohmi
B51T2565	T25	φ5.5×15	H8	65	V-5	V-24T
B51T25110				110		
B51T3065	T30	φ6.5×15		65		
B51T30110				110		
B51T4065	T40	φ7.0×15		65		
B51T40110				110		
B51T4565	T45	φ8.0×15		65		
B51T45110				110		
B51T5065	T50			65		
B51T50110				110		

※ Tamper resistance available upon request.  
 ※ ご希望に応じジリ止め付きについても対応致します。

# Screw tightening robot bits



## ネジ締め用ロボットビット

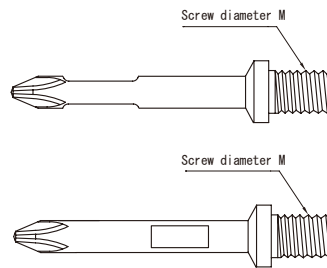

We can manufacture robot bits if provided with drawings and sizes.  
 図面、サイズなどご指示頂ければロボットビットの製作も承ります。

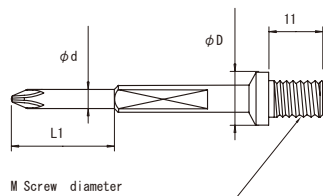

SIZE	L	L 1	L 2	$\phi D$	$\phi d$	t	M

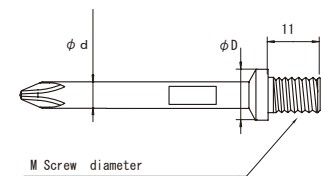
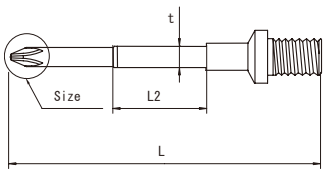

SIZE	L	L 1	L 2	$\phi D$	$\phi d$	t	M

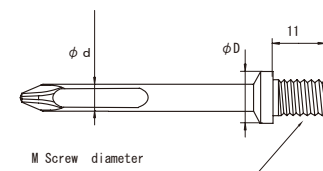
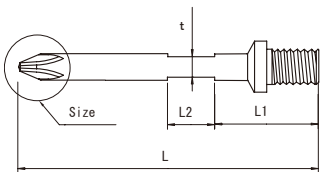

SIZE	L	L 1	L 2	$\phi D$	$\phi d$	t	M

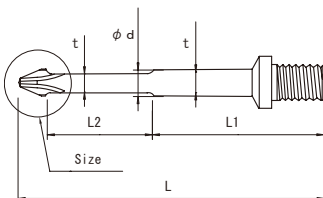

ドライバービット

# Socket bits

## ソケットビット

MODEL **B-35B** 6.35mm

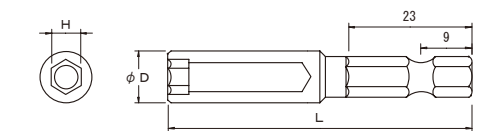

Type A

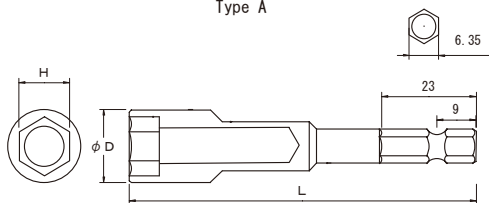

Type B

EDP #	Type	Hex opening(H)	O/D	L	Notes
35B0555	A	5	8	55	
35B0570	A	5	8	70	
35B5555	A	5.5	9	55	
35B5570	A	5.5	9	70	
35B55100	A	5.5	9	100	
35B0655	A	6	10	55	
35B0670	A	6	10	70	
35B06100	A	6	10	100	
35B0755	A	7	11	55	
35B0770	A	7	11	70	
35B07100	A	7	11	100	
35B0855	B	8	13	55	
35B0870	B	8	13	70	
35B08100	B	8	13	100	
35B08150	B	8	13	150	
35B1055	B	10	16	55	
35B1070	B	10	16	70	
35B10100	B	10	16	100	
35B10150	B	10	16	150	
35B1255	B	12	18	55	
35B1270	B	12	18	70	
35B12100	B	12	18	100	
35B12150	B	12	18	150	
35B1370	B	13	19	70	
35B13100	B	13	19	100	
35B1470	B	14	20	70	
35B14100	B	14	20	100	
35B14150	B	14	20	150	

※We can also manufacture products longer than 200mm total length.  
 ※ご要望に応じL200mm以上の製品も製作致します

MODEL **B-35B** 6.35mm

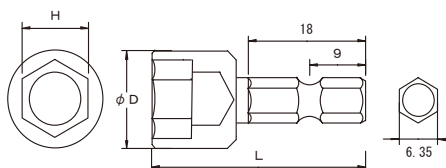

EDP #	Hex opening(H)	O/D	L	Notes
35B0532	5	8	32	
35B5532	5.5	9	32	
35B0632	6	10	32	
35B0732	7	11	32	
35B0832	8	13	32	
35B0932	9	13	32	
35B1032	10	16	32	
35B1232	12	18	32	



# Socket bits



## ソケットビット

Hex lobe

MODEL **B-35BE** 6.35mm

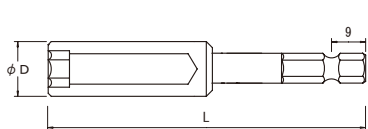

Type A

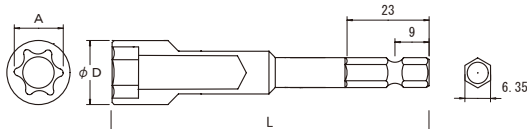

Type B

EDP #	Type	A dimensions	O/D	L	Notes
35BE0470	A	3.8(E4)	7	70	
35BE0570	A	4.7(E5)	8	70	
35BE0670	B	5.7(E6)	10	70	
35BE0870	B	7.5(E8)	12	70	
35BE1070	B	9.4(E10)	14	70	

B-35 and B-39 dual-use type "Double-groove"

MODEL **B-37BW** 6.35mm

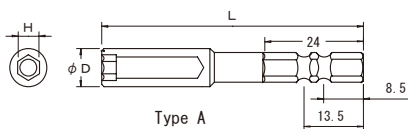

Type A

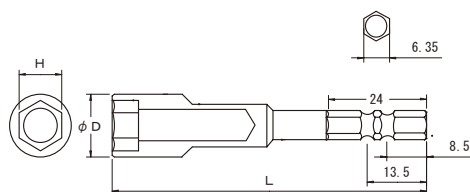

Type B

EDP #	Type	Hex opening(H)	O/D	L	Notes
37BW0555	A	5	8	55	
37BW0570	A	5	8	70	
37BW5555	A	5.5	9	55	
37BW5570	A	5.5	9	70	
37BW55100	A	5.5	9	100	
37BW0655	A	6	10	55	
37BW0670	A	6	10	70	
37BW06100	A	6	10	100	
37BW0755	A	7	11	55	
37BW0770	A	7	11	70	
37BW07100	A	7	11	100	
37BW0855	B	8	13	55	
37BW0870	B	8	13	70	
37BW08100	B	8	13	100	
37BW08150	B	8	13	150	
37BW1055	B	10	16	55	
37BW1070	B	10	16	70	
37BW10100	B	10	16	100	
37BW10150	B	10	16	150	
37BW1255	B	12	18	55	
37BW1270	B	12	18	70	
37BW12100	B	12	18	100	
37BW12150	B	12	18	150	
37BW1370	B	13	19	70	
37BW13100	B	13	19	100	
37BW1470	B	14	20	70	
37BW14100	B	14	20	100	
37BW14150	B	14	20	150	

※We can also manufacture products longer than 200mm total length.  
 ※ご希望に応じL200mm以上の製品も製作致します

ソケットビット

# Socket bits

## ソケットビット

MODEL **B-39B** 6.35mm 

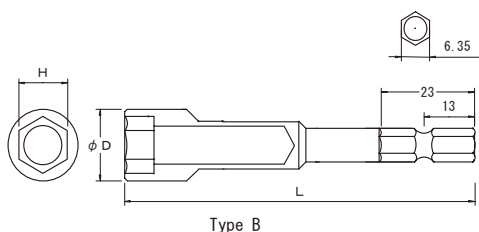
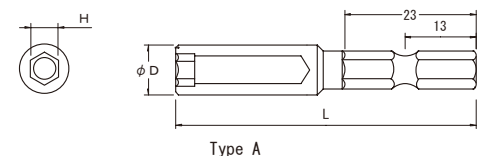

EDP #	type	Hex opening(H)	O/D	L	Notes
39B0555	A	5	8	55	
39B5555	A	5.5	9	55	
39B0655	A	6	10	55	
39B0755	A	7	11	55	
39B07100	A	7	11	100	
39B0855	B	8	13	55	
39B0870	B	8	13	70	
39B08100	B	8	13	100	
39B1055	B	10	16	55	
39B1070	B	10	16	70	
39B10100	B	10	16	100	
39B10150	B	10	16	150	
39B1255	B	12	18	55	
39B1270	B	12	18	70	
39B12100	B	12	18	100	
39B12150	B	12	18	150	
39B1355	B	13	19	55	
39B13100	B	13	19	100	
39B1455	B	14	20	55	
39B14100	B	14	20	100	
39B1755	B	17	25	55	
39B17100	B	17	25	100	

※We can also manufacture products longer than 200mm total length.  
 ※ご希望に応じL200mm以上の製品も製作致します

MODEL **B-51B** 8mm 

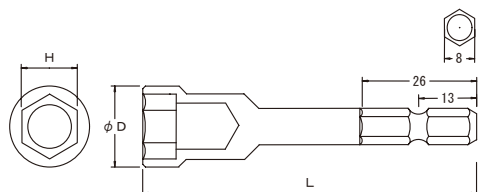

EDP #	Hex opening(H)	O/D	L	Notes
51B10100	10	16	100	
51B12100	12	18	100	
51B14100	14	20	100	
51B17100	17	26	100	

# Socket bits



## ソケットビット

MODEL **B-31B** 5mm

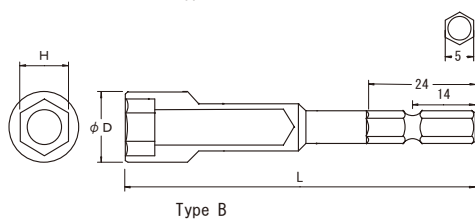
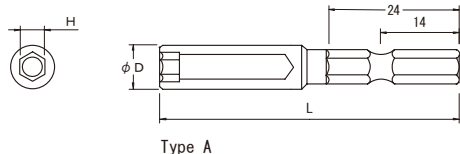

EDP #	type	Hex opening(H)	O/D	L	Notes
31 B0470	A	4	7	70	
31 B4570	A	4.5	7	70	
31 B0570	A	5	8	70	
31 B5570	A	5.5	9	70	
31 B55100	A	5.5	9	100	
31 B0670	A	6	10	70	
31 B06100	A	6	10	100	
31 B0770	A	7	11	70	
31 B07100	A	7	11	100	
31 B0870	B	8	13	70	
31 B08100	B	8	13	100	
31 B08150	B	8	13	150	
31 B0970	B	9	13	70	
31 B09100	B	9	13	100	
31 B1070	B	10	16	70	
31 B10100	B	10	16	100	
31 B10150	B	10	16	150	
31 B1170	B	11	16	70	
31 B11100	B	11	16	100	
31 B1270	B	12	18	70	
31 B12100	B	12	18	100	
31 B12150	B	12	18	150	
31 B1370	B	13	19	70	
31 B13100	B	13	19	100	
31 B1470	B	14	20	70	
31 B14100	B	14	20	100	
31 B14150	B	14	20	150	

# Universal socket bits

## ユニバーサルソケットビット

MODEL **B-35BU** 6.35mm

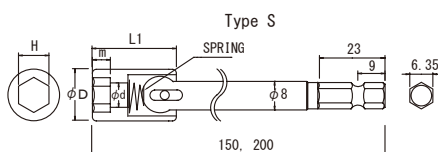
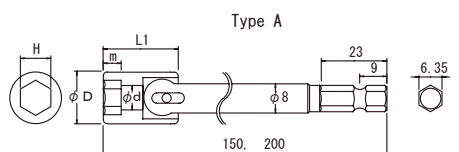
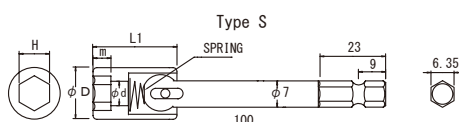
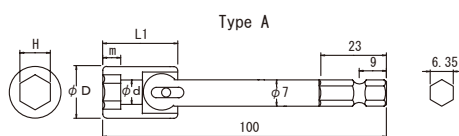

EDP #	Type	Hex opening(H)	O/D	L	Notes
35BU08100A	A	8	16	100	
35BU08150A	A	8	16	150	
35BU08200A	A	8	16	200	
35BU10100A	A	10	18	100	
35BU10150A	A	10	18	150	
35BU10200A	A	10	18	200	
35BU12100A	A	12	20	100	
35BU12150A	A	12	20	150	
35BU12200A	A	12	20	200	
35BU14100A	A	14	21	100	
35BU14150A	A	14	21	150	
35BU14200A	A	14	21	200	
35SU08100S	S	8	16	100	
35BU08150S	S	8	16	150	
35BU08200S	S	8	16	200	
35BU10100S	S	10	18	100	
35BU10150S	S	10	18	150	
35BU10200S	S	10	18	200	
35BU12100S	S	12	20	100	
35BU12150S	S	12	20	150	
35BU12200S	S	12	20	200	
35BU14100S	S	14	21	100	
35BU14150S	S	14	21	150	
35BU14200S	S	14	21	200	

※We can also manufacture products longer than 200mm total length.  
 ※ご要望に応じL200mm以上の製品も製作致します

# Socket bits with Magnet

## Mg 入りソケットビット

Press-in magnets

MODEL **B-31BM** 5mm



EDP #	Type	Hex opening(H)	O/D	L	Notes
31BM0570	A	5	8	70	
31BM5570	A	5.5	9	70	
31BM0670	A	6	10	70	
31BM0770	A	7	11	70	
31BM08100	B	8	13	100	
31BM10100	B	10	16	100	
31BM12100	B	12	18	100	
31BM13100	B	13	19	100	

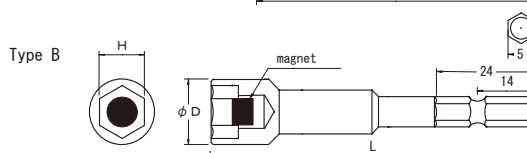
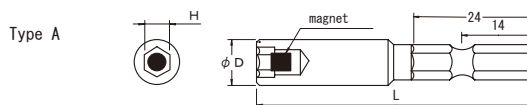

# Socket bits with Magnet



## Mg 入りソケットビット

### Press-in magnets

MODEL **B-35BM** 6.35mm

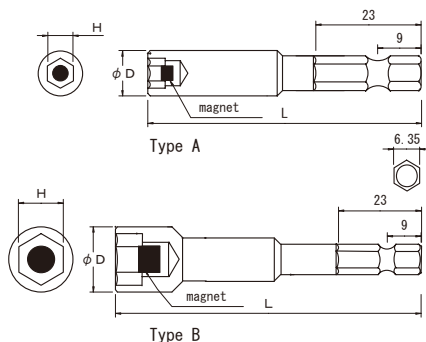

EDP #	Type	Hex opening(H)	O/D	L	Notes
35BM5570	A	5.5	9	70	
35BM55100	A	5.5	9	100	
35BM0670	A	6.0	10	70	
35BM06100	A	6.0	10	100	
35BM0755	B	7.0	11	55	
35BM0770	B	7.0	11	70	
35BM07100	B	7.0	11	100	
35BM0855	B	8.0	13	55	
35BM0870	B	8.0	13	70	
35BM08100	B	8.0	13	100	
35BM1055	B	10	16	55	
35BM1070	B	10	16	70	
35BM10100	B	10	16	100	
35BM1255	B	12	18	55	
35BM1270	B	12	18	70	
35BM12100	B	12	18	100	
35BM1470	B	14	20	70	
35BM14100	B	14	20	100	

ソケットビット

### Press-in magnets

MODEL **B-39BM** 6.35mm



EDP #	Hex opening(H)	O/D	L	Notes
39BM0755	7.0	11	55	
39BM07100	7.0	11	100	
39BM0855	8.0	13	55	
39BM08100	8.0	13	100	
39BM1055	10	16	55	
39BM10100	10	16	100	
39BM1255	12	18	55	
39BM12100	12	18	100	

※Please inquire concerning manufacturing products longer than 150mm for each of these magnet types.  
 ※各種マグネット入りともL150mm以上の製品の製作もご相談に応じます

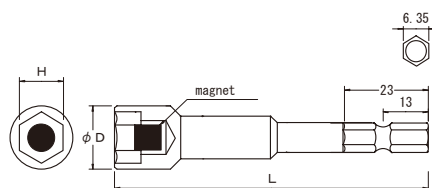



# Socket bits with Magnet

## Mg 入りソケットビット

### Ring magnets

MODEL **B-35BRM** 6.35mm

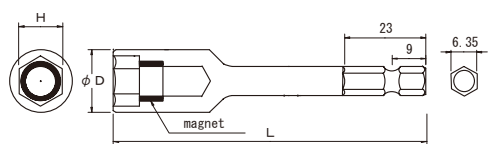

EDP #	Hex opening(H)	O/D	L	Notes
35BRM0870	8	14	70	
35BRM08100	8	14	100	
35BRM1070	10	16	70	
35BRM10100	10	16	100	
35BRM1270	12	18	70	
35BRM12100	12	18	100	
35BRM1370	13	19	70	
35BRM13100	13	19	100	
35BRM1470	14	20	70	
35BRM14100	14	20	100	

### Side magnets

MODEL **B-35BPM** 6.35mm

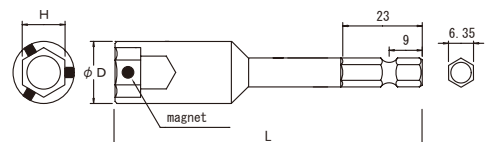

EDP #	Hex opening(H)	O/D	L	Notes
35BPM0870	8.0	14	70	
35BPM08100	8.0	14	100	
35BPM1070	10	16	70	
35BPM10100	10	16	100	
35BPM1270	12	18	70	
35BPM12100	12	18	100	

### Slide magnets

MODEL **B-35BSM** 6.35mm

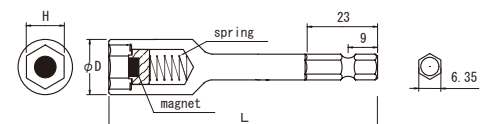

EDP #	Hex opening(H)	O/D	L	Notes
35BSM0870	8.0	13	70	
35BSM08100	8.0	13	100	
35BSM08150	8.0	13	150	
35BSM1070	10	16	70	
35BSM10100	10	16	100	
35BSM10150	10	16	150	
35BSM1270	12	18	70	
35BSM12100	12	18	100	
35BSM12150	12	18	150	
35BSM1370	13	19	70	
35BSM13100	13	19	100	
35BSM13150	13	19	150	
35BSM14100	14	21	100	
35BSM14150	14	21	150	

※Please inquire concerning manufacturing products longer than 150mm for each of these magnet types.  
 ※各種マグネット入りともL150mm以上の製品の製作もご相談に応じます

# SPECIAL PARTS

Please indicate the required dimensions as per the chart below. If dimensions are not indicated, we will use our standard specifications.



## Socket bits

下記表にて必要寸法をご指示ください。  
指示のない寸法については弊社規格となります。

### Socket bits

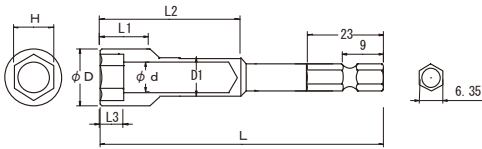

H	$\phi D$	L 1	L 2	L 3	$\phi d$	L

### Socket bits with Magnet

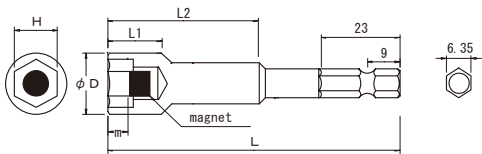

H	$\phi D$	L 1	L 2	m	L

### Socket bits with Ring magnet

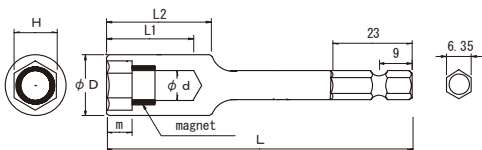

H	$\phi D$	L 1	L 2	m	$\phi d$	L

### Socket bits with Slide magnet

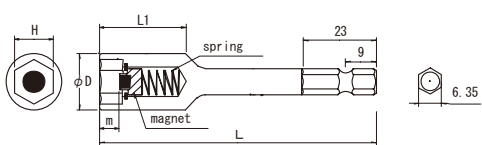

H	$\phi D$	L 1	m	L

### Universal socket bits with SP

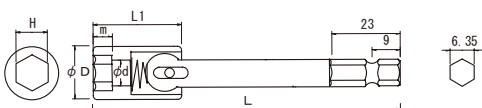

H	$\phi D$	L 1	m	$\phi d$	L

ソケットビット

# IMPACT SOCKETS 9.5sq[3/8"]

## インパクトソケット

### MODEL Short type 6PT

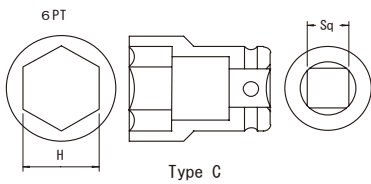
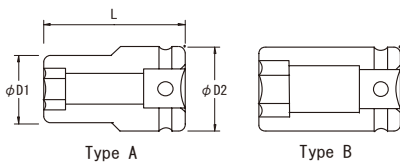

EDP #	Type	H	Sq	D1	D2	L
BP307	A	7	9.5	13	20	32
BP308	A	8	9.5	14	20	32
BP309	A	9	9.5	15	20	32
BP310	A	10	9.5	17	20	32
BP312	B	12	9.5	20	20	32
BP313	C	13	9.5	21	20	32
BP314	C	14	9.5	22	20	32
BP315	C	15	9.5	23	20	32
BP316	C	16	9.5	25	20	35
BP317	C	17	9.5	26	20	35
BP318	C	18	9.5	27	20	35
BP319	C	19	9.5	28	20	35
BP321	C	21	9.5	32	20	35

### MODEL Short type 12PT

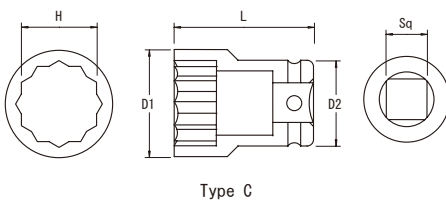

EDP #	Type	H	Sq	D1	D2	L
BP308W	A	8	9.5	14	20	32
BP310W	A	10	9.5	17	20	32
BP312W	B	12	9.5	20	20	32
BP313W	C	13	9.5	21	20	32
BP314W	C	14	9.5	22	20	32
BP316W	C	16	9.5	25	20	35
BP317W	C	17	9.5	26	20	35
BP319W	C	19	9.5	28	20	35

# IMPACT SOCKETS 9.5sq[3/8"]

**BiX**

## インパクトソケット

### MODEL Long type

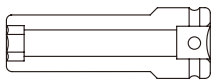

Type A

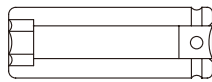

Type B

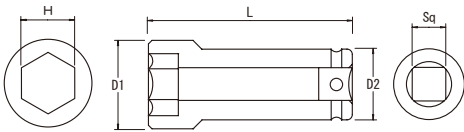

Type C

EDP #	Type	H	Sq	D1	D2	L
BP30750	A	7	9.5	13	20	50
BP30770	A	7	9.5	13	20	70
BP30850	A	8	9.5	14	20	50
BP30870	A	8	9.5	14	20	70
BP31050	A	10	9.5	17	20	50
BP31070	A	10	9.5	17	20	70
BP310100	A	10	9.5	17	20	100
BP31250	B	12	9.5	20	20	50
BP31270	B	12	9.5	20	20	70
BP312100	B	12	9.5	20	20	100
BP31350	C	13	9.5	21	20	50
BP31370	C	13	9.5	21	20	70
BP313100	C	13	9.5	21	20	100
BP31450	C	14	9.5	22	20	50
BP31470	C	14	9.5	22	20	70
BP314100	C	14	9.5	22	20	100
BP31650	C	16	9.5	25	20	50
BP31670	C	16	9.5	25	20	70
BP31750	C	17	9.5	26	20	50
BP31770	C	17	9.5	26	20	70
BP31950	C	19	9.5	28	20	50
BP31970	C	19	9.5	28	20	70

### MODEL Extension type

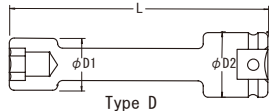

Type D



EDP #	Type	H	Sq	D1	D2	L
BX310100	D	10	9.5	17	20	100
BX310150	D	10	9.5	17	20	150
BX310200	D	10	9.5	17	20	200
BX312100	D	12	9.5	20	20	100
BX312150	D	12	9.5	20	20	150
BX312200	D	12	9.5	20	20	200
BX313100	D	13	9.5	21	20	100
BX313150	D	13	9.5	21	20	150
BX313200	D	13	9.5	21	20	200
BX314100	D	14	9.5	22	20	100
BX314150	D	14	9.5	22	20	150
BX314200	D	14	9.5	22	20	200
BX316100	D	16	9.5	25	20	100
BX316150	D	16	9.5	25	20	150
BX316200	D	16	9.5	25	20	200
BX317100	D	17	9.5	26	20	100
BX317150	D	17	9.5	26	20	150
BX317200	D	17	9.5	26	20	200

インパクトソケット

# IMPACT SOCKETS 9.5sq[3/8"]

## インパクトソケット

### MODEL Hex bit socket

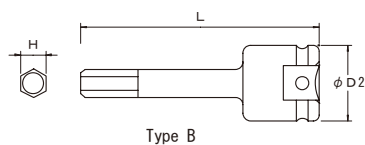
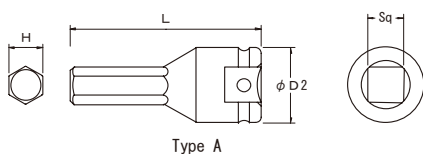

EDP #	Type	H	Sq	D2	L
BP304H42	A	4	9.5	20	42
BP305H42	A	5	9.5	20	42
BP305H60	B	5	9.5	20	60
BP305H90	B	5	9.5	20	90
BP306H42	A	6	9.5	20	42
BP306H60	B	6	9.5	20	60
BP306H90	B	6	9.5	20	90
BP308H42	A	8	9.5	20	42
BP308H60	B	8	9.5	20	60
BP308H90	B	8	9.5	20	90
BP310H42	A	10	9.5	20	42
BP310H60	B	10	9.5	20	60
BP310H90	B	10	9.5	20	90
BP312H42	A	12	9.5	20	42
BP314H42	A	14	9.5	20	42

※We can also manufacture products for inch size.  
 ※インチサイズも製作致します。

### MODEL Socket for tap

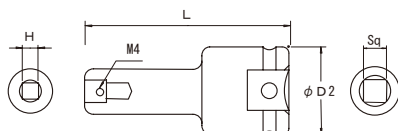

EDP #	H	Sq	D2	L
BP340TS	4	9.5	20	42
BP345TS	4.5	9.5	20	42
BP350TS	5	9.5	20	42
BP355TS	5.5	9.5	20	42
BP365TS	6.5	9.5	20	42

Use the screw (M4) to attach the tap.  
 タップをねじ (M4)で取り付けてください。



# IMPACT SOCKETS 9.5sq[3/8"]

**BiX**

## インパクトソケット

### MODEL Stud socket

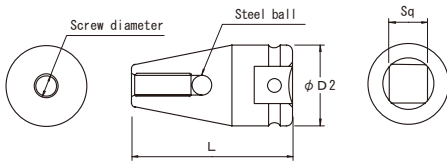

EDP #	Screws nominal diameter	Sq	D2	L
BP305P08	M5-P0.8	9.5	20	42
BP306P10	M6-P1.0	9.5	20	42
BP308P12	M8-P1.25	9.5	20	42
BP310P12	M10-P1.25	9.5	20	42
BP310P15	M10-P1.5	9.5	20	42

### MODEL Hexlobe socket

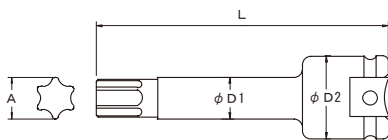

Type T

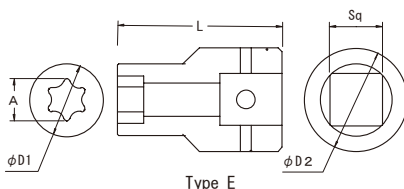

Type E

EDP #	Type	A	Sq	D1	D2	L
BP320T	T	3.8(T20)	9.5	7	20	70
BP325T	T	4.4(T25)	9.5	8	20	70
BP327T	T	5.0(T27)	9.5	8	20	70
BP330T	T	5.5(T30)	9.5	8	20	70
BP340T	T	6.6(T40)	9.5	10	20	70
BP345T	T	7.8(T45)	9.5	10	20	70
BP350T	T	8.8(T50)	9.5	13	20	70
BP305E	E	4.7(E5)	9.5	10	20	32
BP306E	E	5.7(E6)	9.5	11	20	32
BP308E	E	7.5(E8)	9.5	13	20	32
BP310E	E	9.4(E10)	9.5	15	20	32
BP312E	E	11.1(E12)	9.5	17	20	32

インパクトソケット

# IMPACT SOCKETS 12.7sq[1/2"]

## インパクトソケット

### MODEL Short type 6PT

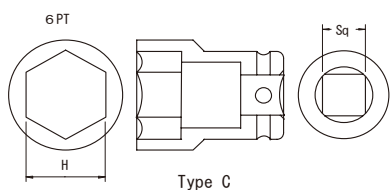
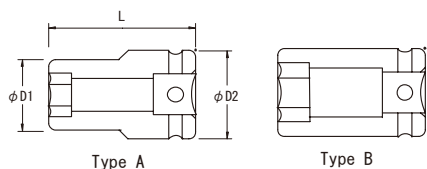

EDP #	Type	H	Sq	D1	D2	L
BP408	A	8	12.7	16	25	40
BP409	A	9	12.7	17	25	40
BP410	A	10	12.7	18	25	40
BP412	A	12	12.7	21	25	40
BP413	A	13	12.7	22	25	40
BP414	A	14	12.7	23	25	40
BP415	A	15	12.7	24	25	40
BP416	B	16	12.7	25	25	40
BP417	B	17	12.7	28	28	42
BP418	C	18	12.7	29	28	42
BP419	C	19	12.7	30	28	42
BP421	C	21	12.7	33	28	42
BP422	C	22	12.7	34	28	42
BP423	C	23	12.7	35	28	45
BP424	C	24	12.7	36	28	45
BP426	C	26	12.7	39	28	45

### MODEL Short type 12PT

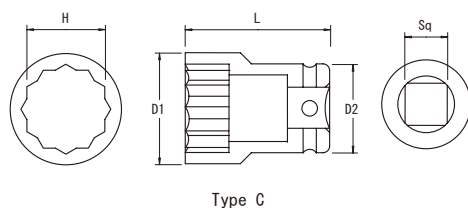

EDP #	Type	H	Sq	D1	D2	L
BP408W	A	8	12.7	16	25	40
BP410W	A	10	12.7	18	25	40
BP412W	A	12	12.7	21	25	40
BP413W	A	13	12.7	22	25	40
BP414W	A	14	12.7	23	25	40
BP416W	B	16	12.7	25	25	40
BP417W	B	17	12.7	28	28	42
BP419W	C	19	12.7	30	28	42
BP421W	C	21	12.7	33	28	42
BP422W	C	22	12.7	34	28	42
BP423W	C	23	12.7	35	28	45
BP424W	C	24	12.7	36	28	45
BP426W	C	26	12.7	39	28	45

# IMPACT SOCKETS 12.7sq[1/2"]

**BiX**

## インパクトソケット

### MODEL Long type

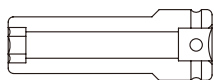

Type A



Type B

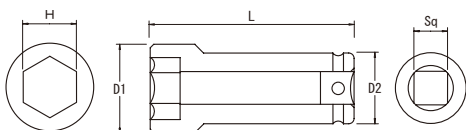

Type C

EDP #	Type	H	Sq	D1	D2	L
BP40850	A	8	12.7	16	25	50
BP40875	A	8	12.7	16	25	75
BP41050	A	10	12.7	18	25	50
BP41075	A	10	12.7	18	25	75
BP410100	A	10	12.7	18	25	100
BP41250	A	12	12.7	21	25	50
BP41275	A	12	12.7	21	25	75
BP412100	A	12	12.7	21	25	100
BP41350	A	13	12.7	22	25	50
BP41375	A	13	12.7	22	25	75
BP413100	A	13	12.7	22	25	100
BP41450	A	14	12.7	23	25	50
BP41475	A	14	12.7	23	25	75
BP414100	A	14	12.7	23	25	100
BP41650	B	16	12.7	25	25	50
BP41675	B	16	12.7	25	25	75
BP416100	B	16	12.7	25	25	100
BP41750	B	17	12.7	28	28	50
BP41775	B	17	12.7	28	28	75
BP417100	B	17	12.7	28	28	100
BP41950	C	19	12.7	30	28	50
BP41975	C	19	12.7	30	28	75
BP419100	C	19	12.7	30	28	100
BP42150	C	21	12.7	33	28	50
BP42175	C	21	12.7	33	28	75
BP421100	C	21	12.7	33	28	100
BP42250	C	22	12.7	34	28	50
BP42275	C	22	12.7	34	28	75

### MODEL Extension type



Type D

EDP #	Type	H	Sq	D1	D2	L
BX412100	D	12	12.7	20	25	100
BX412150	D	12	12.7	20	25	150
BX412200	D	12	12.7	20	25	200
BX413100	D	13	12.7	21	25	100
BX413150	D	13	12.7	21	25	150
BX413200	D	13	12.7	21	25	200
BX414100	D	14	12.7	22	25	100
BX414150	D	14	12.7	22	25	150
BX414200	D	14	12.7	22	25	200
BX416100	D	16	12.7	25	25	100
BX416150	D	16	12.7	25	25	150
BX416200	D	16	12.7	25	25	200
BX417100	D	17	12.7	26	28	100
BX417150	D	17	12.7	26	28	150
BX417200	D	17	12.7	26	28	200
BX419100	D	19	12.7	28	28	100
BX419150	D	19	12.7	28	28	150
BX419200	D	19	12.7	28	28	200

インパクトソケット

# IMPACT SOCKETS 12.7sq[1/2"]

## インパクトソケット

### MODEL Hex bit socket



EDP #	Type	H	Sq	D2	L
BP404H50	A	4	12.7	25	50
BP405H50	A	5	12.7	25	50
BP406H50	A	6	12.7	25	50
BP406H70	B	6	12.7	25	70
BP406H100	B	6	12.7	25	100
BP408H50	A	8	12.7	25	50
BP408H70	B	8	12.7	25	70
BP408H100	B	8	12.7	25	100
BP410H50	A	10	12.7	25	50
BP410H70	B	10	12.7	25	70
BP410H100	B	10	12.7	25	100
BP412H50	A	12	12.7	25	50
BP412H70	B	12	12.7	25	70
BP412H100	B	12	12.7	25	100
BP414H50	A	14	12.7	25	50
BP417H50	A	17	12.7	25	50

※We can also manufacture products for inch size.  
 ※インチサイズも製作致します。

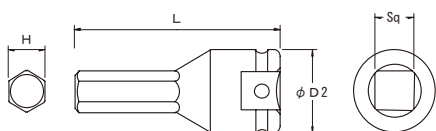

Type A

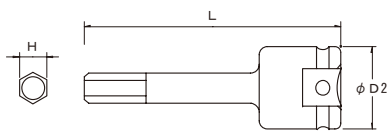

Type B

### MODEL Socket for tap



EDP #	Type	H	Sq	D2	L
BP445TS	A	4.5	12.7	25	50
BP450TS	A	5	12.7	25	50
BP455TS	A	5.5	12.7	25	50
BP465TS	A	6.5	12.7	25	50
BP480TS	A	8	12.7	25	50
BP410TS	A	10	12.7	25	50
BP411TS	A	11	12.7	25	50

Use the screw (M4) to attach the tap.  
 タップをねじ (M4)で取り付けてください。

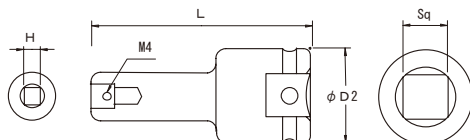

# IMPACT SOCKETS 12.7sq[1/2"]

**BiX**

## インパクトソケット

### MODEL Stud socket

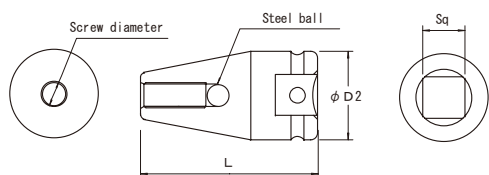

EDP #	Screws nominal diameter	Sq	D2	L
BP406P10	M6-P1.0	12.7	25	50
BP408P12	M8-P1.25	12.7	25	50
BP410P12	M10-P1.25	12.7	25	50
BP410P15	M10-P1.5	12.7	25	50
BP412P12	M12-P1.25	12.7	25	50
BP412P15	M12-P1.5	12.7	25	50
BP412P17	M12-P1.75	12.7	25	50
BP414P15	M14-P1.5	12.7	25	50
BP414P20	M14-P2.0	12.7	25	50
BP416P15	M16-P1.5	12.7	25	50
BP416P20	M16-P2.0	12.7	25	50
BP418P25	M18-P2.5	12.7	25	50
BP420P25	M20-P2.5	12.7	28	50

### MODEL Hex lobe socket

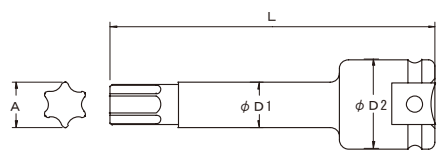

Type T

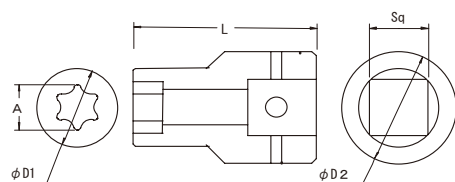

Type E

EDP #	Type	A	Sq	D1	D2	L
BP430T	T	5.5(T30)	12.7	8	25	75
BP440T	T	6.6(T40)	12.7	10	25	75
BP445T	T	7.8(T45)	12.7	10	25	75
BP450T	T	8.8(T50)	12.7	13	25	75
BP455T	T	11.2(T55)	12.7	13	25	75
BP460T	T	13.2(T60)	12.7	15	25	75
BP408E	E	7.5(E8)	12.7	12.2	25	38
BP410E	E	9.4(E10)	12.7	14.2	25	40
BP412E	E	11.1(E12)	12.7	16.2	25	40
BP414E	E	12.8(E14)	12.7	18.2	25	40
BP416E	E	14.7(E16)	12.7	20.2	25	40
BP418E	E	16.6(E18)	12.7	22.2	25	40
BP420E	E	18.4(E20)	12.7	24.2	28	42

インパクトソケット



# IMPACT SOCKETS 19sq[3/4" ]

## インパクトソケット

MODEL **Short type 6PT**

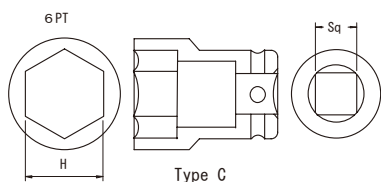
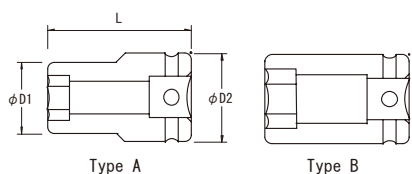

EDP #	Type	H	Sq	D1	D2	L
BP614	A	14	19	24	38	55
BP617	A	17	19	30	38	55
BP619	A	19	19	32	38	55
BP621	A	21	19	35	38	55
BP622	A	22	19	36	38	55
BP623	B	23	19	38	38	55
BP624	B	24	19	40	40	55
BP626	B	26	19	42	42	55
BP627	C	27	19	44	42	55
BP629	C	29	19	46	42	60
BP630	C	30	19	48	42	60
BP632	C	32	19	49	42	60

# IMPACT SOCKETS 19sq[3/4" ]

**BiX**

## インパクトソケット

### MODEL Long type



EDP #	Type	H	Sq	D1	D2	L
BP619100	A	19	19	33	38	100
BP621100	A	21	19	35	38	100
BP622100	A	22	19	37	38	100
BP623100	B	23	19	38	38	100
BP624100	B	24	19	40	40	100
BP626100	B	26	19	42	42	100
BP627100	C	27	19	44	42	100
BP629100	C	29	19	47	42	100
BP630100	C	30	19	48	42	100
BP632100	C	32	19	49	42	100

※We can also manufacture products extension type.  
 ※ご希望によりエクステンションTypeも製作致します。

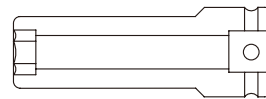

Type A

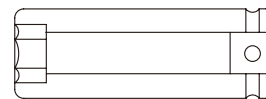

Type B

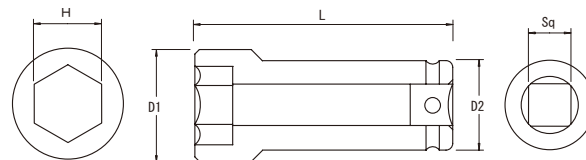

Type C

### MODEL Hex bit socket

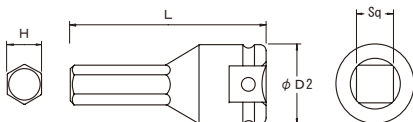

Type A

EDP #	Type	H	Sq	D2	L
BP612H	A	12	19	38	62
BP614H	A	14	19	38	62
BP617H	A	17	19	38	62
BP619H	A	19	19	38	62
BP622H	A	22	19	38	62

インパクトソケット

# Impact sockets with Magnet 「3/8"・1/2"」

## Mg 入りインパクトソケット

### MODEL Short type MG



EDP #	Type	H	Sq	D1	D2	L
BP308MG	A	8	9.5	14	20	32
BP310MG	A	10	9.5	17	20	32
BP312MG	B	12	9.5	20	20	32
BP313MG	C	13	9.5	21	20	32
BP314MG	C	14	9.5	22	20	32
BP316MG	C	16	9.5	24	20	32
BP408MG	A	8	12.7	16	25	40
BP410MG	A	10	12.7	18	25	40
BP412MG	A	12	12.7	21	25	40
BP413MG	A	13	12.7	22	25	40
BP414MG	A	14	12.7	23	25	40
BP416MG	A	16	12.7	25	28	42
BP417MG	B	17	12.7	28	28	42

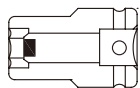

Type A

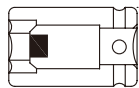

Type B

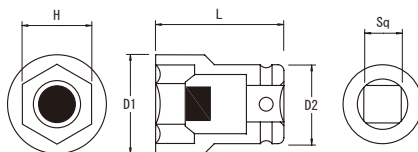

Type C

### MODEL Long type MG



EDP #	Type	H	Sq	D1	D2	L
BP308MG50	A	8	9.5	14	20	50
BP308MG70	A	8	9.5	14	20	70
BP310MG50	A	10	9.5	17	20	50
BP310MG70	A	10	9.5	17	20	70
BP312MG50	B	12	9.5	20	20	50
BP312MG70	B	12	9.5	20	20	70
BP313MG50	C	13	9.5	21	20	50
BP313MG70	C	13	9.5	21	20	70
BP314MG50	C	14	9.5	22	20	50
BP314MG70	C	14	9.5	22	20	70
BP316MG50	C	16	9.5	24	20	50
BP316MG70	C	16	9.5	24	20	70
BP412MG50	A	12	12.7	21	25	50
BP412MG75	A	12	12.7	21	25	75
BP413MG50	A	13	12.7	22	25	50
BP413MG75	A	13	12.7	22	25	70
BP414MG50	A	14	12.7	23	25	50
BP414MG75	A	14	12.7	23	25	75
BP416MG50	A	16	12.7	25	28	50
BP416MG75	A	16	12.7	25	28	75
BP417MG50	B	17	12.7	28	28	50
BP417MG75	B	17	12.7	28	28	75

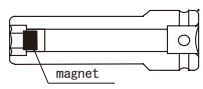

Type A

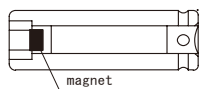

Type B

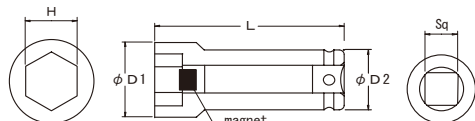

Type C

# Impact sockets with Magnet 「3/8"・1/2"」



## Mg 入りインパクトソケット

### MODEL Extension type MG

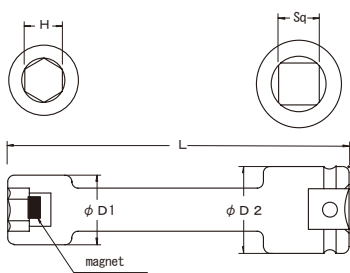

Type D

EDP #	Type	H	Sq	D1	D2	L
BX310MG100	D	10	9.5	17	20	100
BX310MG150	D	10	9.5	17	20	150
BX310MG200	D	10	9.5	17	20	200
BX312MG100	D	12	9.5	20	20	100
BX312MG150	D	12	9.5	20	20	150
BX312MG200	D	12	9.5	20	20	200
BX313MG100	D	13	9.5	21	20	100
BX313MG150	D	13	9.5	21	20	150
BX313MG200	D	13	9.5	21	20	200
BX314MG100	D	14	9.5	22	20	100
BX314MG150	D	14	9.5	22	20	150
BX314MG200	D	14	9.5	22	20	200
BX412MG100	D	12	12.7	21	25	100
BX412MG150	D	12	12.7	21	25	150
BX412MG200	D	12	12.7	21	25	200
BX414MG100	D	14	12.7	23	25	100
BX414MG150	D	14	12.7	23	25	150
BX414MG200	D	14	12.7	23	25	200

### MODEL Slide magnet type

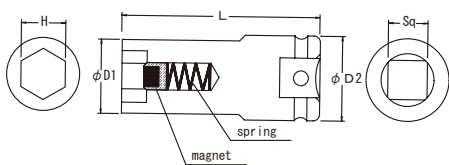

Type A

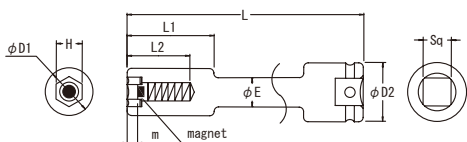

Type D

EDP #	Type	H	Sq	D1	D2	L
BP308SM70	A	8	9.5	14	20	70
BP310SM70	A	10	9.5	17	20	70
BX310SM100	D	10	9.5	17	20	100
BX310SM150	D	10	9.5	17	20	150
BX310SM200	D	10	9.5	17	20	200
BP312SM70	A	12	9.5	20	20	70
BX312SM100	D	12	9.5	20	20	100
BX312SM150	D	12	9.5	20	20	150
BX312SM200	D	12	9.5	20	20	200
BP314SM70	A	14	9.5	22	20	70
BX314SM100	D	14	9.5	22	20	100
BX314SM150	D	14	9.5	22	20	150
BX314SM200	D	14	9.5	22	20	200
BP412SM75	A	12	12.7	21	25	75
BP412SM100	A	12	12.7	21	25	100
BX412SM150	D	12	12.7	21	25	150
BX412SM200	D	12	12.7	21	25	200
BP413SM75	A	13	12.7	22	25	75
BP413SM100	A	13	12.7	22	25	100
BX413SM150	D	13	12.7	22	25	150
BX413SM200	D	13	12.7	22	25	200
BP414SM75	A	14	12.7	23	25	75
BP414SM100	A	14	12.7	23	25	100
BX414SM150	D	14	12.7	23	25	150
BX414SM200	D	14	12.7	23	25	200

※Type D is in extension configuration.  
 ※Type Dは、エクステンション形状

インパクトソケット

# Impact sockets with Magnet 「3/8"・1/2"」

## Mg 入りインパクトソケット

### MODEL Ring magnet type

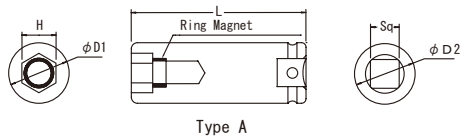

Type A

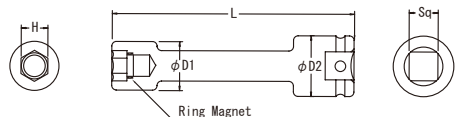

Type D

EDP #	Type	H	Sq	D1	D2	L
BP308RM50	A	8	9.5	14	20	50
BP308RM70	A	8	9.5	14	20	70
BP310RM50	A	10	9.5	17	20	50
BP310RM70	A	10	9.5	17	20	70
BX310RM100	D	10	9.5	17	20	100
BX310RM150	D	10	9.5	17	20	150
BX310RM200	D	10	9.5	17	20	200
BP312RM50	B	12	9.5	20	20	50
BP312RM70	B	12	9.5	20	20	70
BX312RM100	D	12	9.5	20	20	100
BX312RM150	D	12	9.5	20	20	150
BX312RM200	D	12	9.5	20	20	200
BP314RM50	C	14	9.5	22	20	50
BP314RM70	C	14	9.5	22	20	70
BX314RM100	D	14	9.5	22	20	100
BX314RM150	D	14	9.5	22	20	150
BX314RM200	D	14	9.5	22	20	200
BP410RM50	A	10	12.7	17	25	50
BP410RM75	A	10	12.7	17	25	75
BP412RM50	A	12	12.7	20	25	50
BP412RM75	A	12	12.7	20	25	75
BX412RM100	D	12	12.7	20	25	100
BX412RM150	D	12	12.7	20	25	150
BX412RM200	D	12	12.7	20	25	200
BP414RM50	A	14	12.7	22	25	50
BP414RM75	A	14	12.7	22	25	75
BX414RM100	D	14	12.7	22	25	100
BX414RM150	D	14	12.7	22	25	150
BX414RM200	D	14	12.7	22	25	200

※Type D is in extension configuration.  
 ※Type D はエクステンション形状となります。



# Universal impact sockets 「3/8"・1/2"」

**BiX**

## ユニバーサルインパクトソケット

### MODEL **Universal socket**

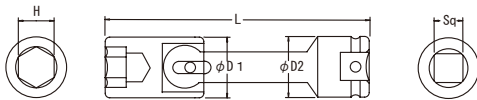

※Specify when ordering a socket with a spring.  
 ※スプリング付は御指定ください。

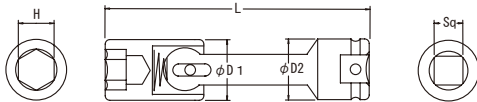

EDP #	Sq	H	D1	D2	L
BU31055	9.5	10	16	20	55
BU310100	9.5	10	16	20	100
BU310150	9.5	10	16	20	150
BU310200	9.5	10	16	20	200
BU31255	9.5	12	20	20	55
BU312100	9.5	12	20	20	100
BU312150	9.5	12	20	20	150
BU312200	9.5	12	20	20	200
BU31455	9.5	14	22	20	55
BU314100	9.5	14	22	20	100
BU314150	9.5	14	22	20	150
BU314200	9.5	14	22	20	200
BU31755	9.5	17	25	20	55
BU41270	12.7	12	21	25	70
BU412100	12.7	12	21	25	100
BU412150	12.7	12	21	25	150
BU412200	12.7	12	21	25	200
BU41370	12.7	13	22	25	70
BU41470	12.7	14	23	25	70
BU414100	12.7	14	23	25	100
BU414150	12.7	14	23	25	150
BU414200	12.7	14	23	25	200
BU41770	12.7	17	28	26	70
BU417100	12.7	17	28	26	100
BU417150	12.7	17	28	26	150
BU417200	12.7	17	28	26	200

### MODEL **Universal joint**

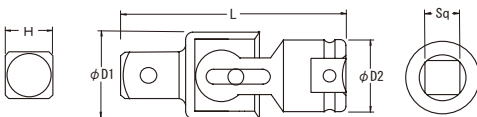

EDP #	Sq	H	D1	D2	L
BUJ303	9.5	9.5	21	20	50
BUJ404	12.7	12.7	30	29	73
BUJ606	12.7	19	48	40	112

インパクトソケット

# Adapters · Extension bars

## アダプター・エクステンションバー

### MODEL Extension bar

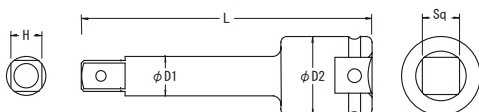

EDP #	Sq	H	D1	D2	L
BXB375	9.5	9.5	13	20	75
BXB3100	9.5	9.5	13	20	100
BXB3150	9.5	9.5	13	20	150
BXB3200	9.5	9.5	13	20	200
BXB4100	12.7	12.7	17	25	100
BXB4150	12.7	12.7	17	25	150
BXB4200	12.7	12.7	17	25	200
BXB6150	19	19	25	38	150
BXB6200	19	19	25	38	200

### MODEL Bit chuck



EDP #	Type	H	Sq	Application bit
BBA302B	Ball type	6.35	9.5	B-15 B-35
BBA402B	Ball type	6.35	12.7	B-15 B-35
BBA302S	Chuck Type	6.35	9.5	B-15 B-35
BBA402S	Chuck Type	6.35	12.7	B-12 B-39
BBA302G	Rubber type	6.35	9.5	B-15 B-35
BBA402G	Rubber type	6.35	12.7	B-12 B-39

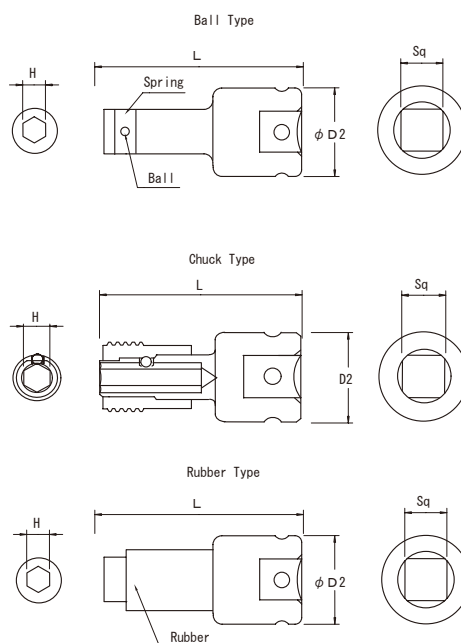

# Adapters · Extension bars



## アダプター・エクステンションバー

### MODEL Bit adapter



EDP #	Type	H	Sq	Application bit	
BDA203	Pin Type	6.35	9.5	B-15	B-35
BDA204	Pin Type	6.35	12.7	B-15	B-35
BDA203B	Ball type	6.35	9.5	B-15	B-35
BDA204B	Ball type	6.35	12.7	B-15	B-35

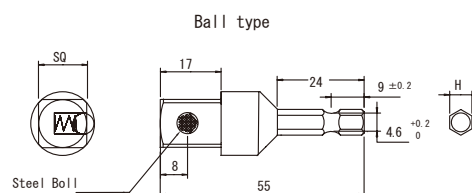
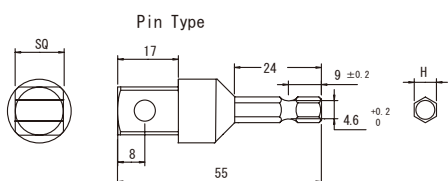

### MODEL Socket adapter



EDP #	Type	Sq	H	D2	L
BSA304	A	9.5	12.7	20	37
BSA403	A	12.7	9.5	25	37
BSA304B	B	9.5	12.7	20	37
BSA403B	B	12.7	9.5	25	37
BSA406	A	12.7	19	25	46
BSA604	A	19	12.7	38	53
BSA608	A	19	25.4	38	70

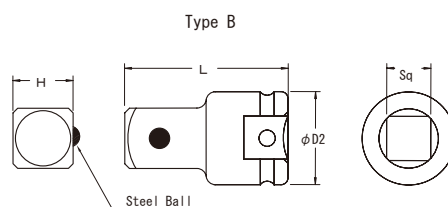
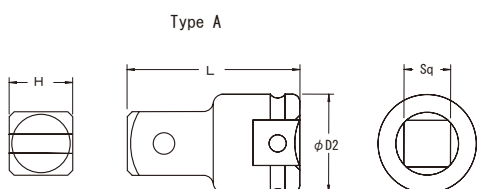

### MODEL Socket adapter type H



EDP #	H1	H2	L
BSA0810	8	10	40
BSA0812	8	12	40
BSA1008	10	8	40
BSA1012	10	12	40
BSA1014	10	14	40
BSA1208	12	8	41
BSA1210	12	10	42
BSA1214	12	14	43
BSA1410	14	10	44
BSA1412	14	12	45
BSA1417	14	17	46
BSA1714	17	14	47

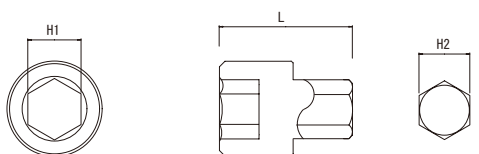

# Adapters · Extension bars

## アダプター・エクステンションバー

### MODEL Bit through socket



EDP #	Type(1)	bit diameter	H	L	Type(2)
BBS208	No magnet type R	6.35	8	60	No ball type
BBS210		6.35	10	60	No ball type
BBS212		6.35	12	60	No ball type
BBS214		6.35	14	60	No ball type
BBS208B	No magnet type B	6.35	8	60	Ball Stopper
BBS210B		6.35	10	60	Ball Stopper
BBS212B		6.35	12	60	Ball Stopper
BBS214B		6.35	14	60	Ball Stopper
BBS208MB	With magnet MB	6.35	8	60	Ball Stopper
BBS210MB		6.35	10	60	Ball Stopper
BBS212MB		6.35	12	60	Ball Stopper
BBS214MB		6.35	14	60	Ball Stopper
BBS208RMB	With ring magnet RMB	6.35	8	60	Ball Stopper
BBS210RMB		6.35	10	60	Ball Stopper
BBS212RMB		6.35	12	60	Ball Stopper
BBS214RMB		6.35	14	60	Ball Stopper
BBS208SMB	With slide magnet SMB	6.35	8	60	Ball Stopper
BBS210SMB		6.35	10	60	Ball Stopper
BBS212SMB		6.35	12	60	Ball Stopper
BBS214SMB		6.35	14	60	Ball Stopper
BBS0810	No magnet	6.35	H1=8 H2=10	70	Type W
BBS1012	type W	6.35	H1=10 H2=12	80	Type W
BBS0810PM	With slide	6.35	H1=8 H2=10	70	Type W
BBS1012PM	magnet WM	6.35	H1=10 H2=12	80	Type W

※We can also manufacture products with magnet.  
※マグネット入りも製作致します。

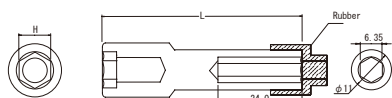

Type R

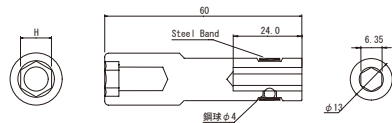

Type B

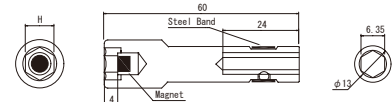

Type MB

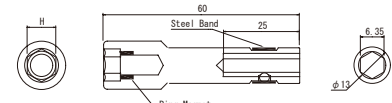

Type RMB

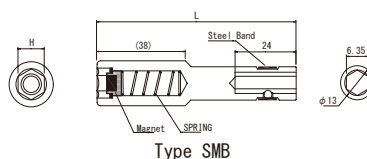

Type SMB

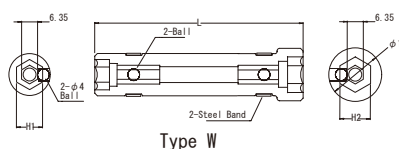

Type W

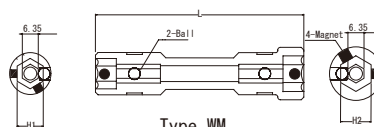

Type WM

※Attach Type R to a bit using a rubber ring separately sold.  
※Type Rは別売ゴムでビットに取付けてください。

# Adapters · Extension bars

**BiX**

## アダプター・エクステンションバー

### MODEL One touch bit through socket



EDP #	bit diameter	H	L	Type
BBS208AT	6.35	※8	36	
BBS210AT	6.35	10	36	
BBS212AT	6.35	12	36	
BBS213AT	6.35	13	38	
BBS214AT	6.35	14	38	

※H8 is a side magnet type.  
※H8はサイドマグネットになります。

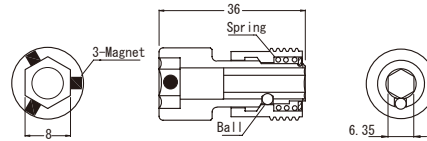
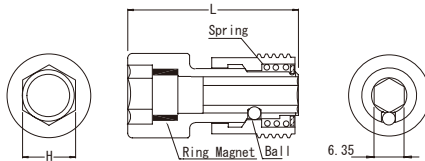

### MODEL Tap holder



EDP #	φ A	B	C	Top size
BTH-5	5.5	4.5	10	M5
BTH-6	6	4.5	10	M6
BTH-8	6.2	5	12	M8
BTH-10	7	5.5	14	M10
BTH-7/16	8	6	16	7/16 UNF
BTH-12	8.5	6.5	17	M12

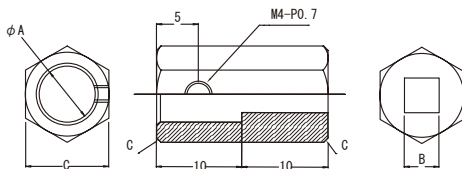

インパクトソケット

※ We can also manufacture tailor-made products based on your drawings and samples.

※その他、図面、サンプル等で特殊品の製作も承ります。



## Features of antivibration sockets 防振ソケットの特長

### Compatible with all brands of oil-pulse drills!!

- Tool and socket connection with deep drive unit minimizes slippage.
- Reliable torque transmission eliminates tightening errors.
- Reduces vibration and noise, for improved working environment.
- Extends tool life.
- The IR and IS types are available for antivibration sockets.
- Each of 3/8", 1/2" and 3/4" drive sockets can be provided.

### 各社オイルパレスレンチに対応!!

- 深くなった駆動部によりツールとソケットを接続し、がたつきを軽減します。
- トルクを確実に伝達し、締め付け不良をなくします。
- 振動と騒音を軽減し、作業環境を改善します。
- ツールの寿命が長くなります。
- 防振ソケットには IR タイプと IS タイプをそろえています。
- 3/8"、1/2"、3/4" Drive の各サイズを制作いたします。

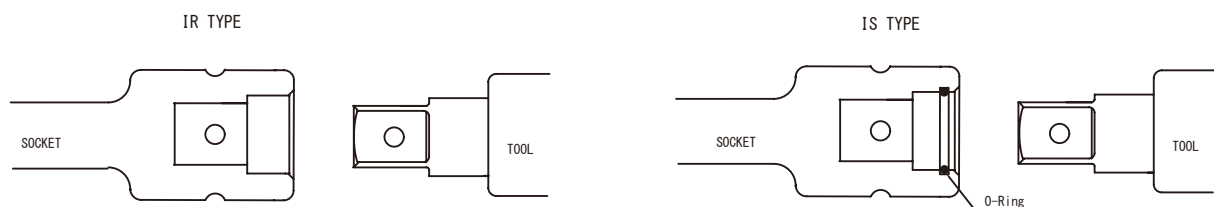

- ※Secured to the main shaft with an O-Ring, vibration of the IS type is further reduced.
- ※Specify individually when ordering the IS type.
- ※IS typeはO-Ringで主軸にしっかり固定されさらに振動が抑制されます。
- ※IS typeにつきましては別途ご指定ください。

# Antivibration socket extension type



## 防振ソケット エクステンションタイプ



### MODEL 3/8" square drive

EDP #	H	Sq	D1	D2	A	L
BX310100IR	10	9.5	17	20	12	100
BX310150IR	10	9.5	17	20	12	150
BX310200IR	10	9.5	17	20	12	200
BX312100IR	12	9.5	20	20	12	100
BX312150IR	12	9.5	20	20	12	150
BX312200IR	12	9.5	20	20	12	200
BX313100IR	13	9.5	21	20	12	100
BX313150IR	13	9.5	21	20	12	150
BX313200IR	13	9.5	21	20	12	200
BX314100IR	14	9.5	22	20	12	100
BX314150IR	14	9.5	22	20	12	150
BX314200IR	14	9.5	22	20	12	200

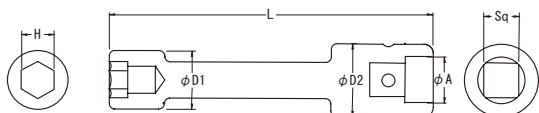

### MODEL 3/4" square drive

EDP #	H	Sq	D1	D2	A	L
BX619100IR	19	19	32	38	25	100
BX619150IR	19	19	32	38	25	150
BX621100IR	21	19	35	38	25	100
BX621150IR	21	19	35	38	25	150

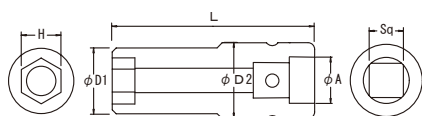

Type BP

### MODEL 1/2" square drive

EDP #	H	Sq	D1	D2	A	L
BX412100IR	12	12.7	20	25	16	100
BX412150IR	12	12.7	20	25	16	150
BX412200IR	12	12.7	20	25	16	200
BX413100IR	13	12.7	21	25	16	100
BX413150IR	13	12.7	21	25	16	150
BX413200IR	13	12.7	21	25	16	200
BX414100IR	14	12.7	22	25	16	100
BX414150IR	14	12.7	22	25	16	150
BX414200IR	14	12.7	22	25	16	200
BX416100IR	16	12.7	25	25	16	100
BX416150IR	16	12.7	25	25	16	150
BX416200IR	16	12.7	25	25	16	200
BX417100IR	17	12.7	26	26	16	100
BX417150IR	17	12.7	26	26	16	150
BX417200IR	17	12.7	26	26	16	200
BX419100IR	19	12.7	28	28	16	100
BX419150IR	19	12.7	28	28	16	150
BX419200IR	19	12.7	28	28	16	200



# Antivibration socket with magnet

## 防振ソケット マグネットタイプ

### MODEL Standard type MG

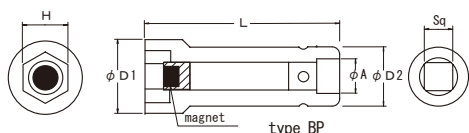

EDP #	H	Sq	D1	D2	A	L
BP308MG50IR	8	9.5	14	20	12	50
BP308MG70IR	8	9.5	14	20	12	70
BP310MG50IR	10	9.5	17	20	12	50
BP310MG70IR	10	9.5	17	20	12	70
BP312MG50IR	12	9.5	20	20	12	50
BP312MG70IR	12	9.5	20	20	12	70
BP314MG50IR	14	9.5	22	20	12	50
BP314MG70IR	14	9.5	22	20	12	70
BP412MG50IR	12	12.7	21	25	16	50
BP412MG75IR	12	12.7	21	25	16	75
BP414MG50IR	14	12.7	23	25	16	50
BP414MG75IR	14	12.7	23	25	16	75
BP417MG50IR	17	12.7	26	26	16	50
BP417MG75IR	17	12.7	26	26	16	75

### MODEL Extension type MG

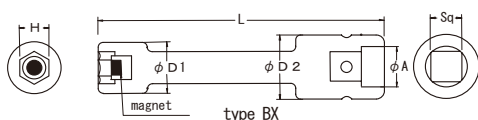

EDP #	H	Sq	D1	D2	A	L
BX310MG100IR	10	9.5	17	20	12	100
BX310MG150IR	10	9.5	17	20	12	150
BX310MG200IR	10	9.5	17	20	12	200
BX312MG100IR	12	9.5	20	20	12	100
BX312MG150IR	12	9.5	20	20	12	150
BX312MG200IR	12	9.5	20	20	12	200
BX314MG100IR	14	9.5	22	20	12	100
BX314MG150IR	14	9.5	22	20	12	150
BX314MG200IR	14	9.5	22	20	12	200
BX410MG100IR	10	12.7	21	25	16	100
BX410MG150IR	10	12.7	21	25	16	150
BX410MG200IR	10	12.7	21	25	16	200
BX412MG100IR	12	12.7	21	25	16	100
BX412MG150IR	12	12.7	21	25	16	150
BX412MG200IR	12	12.7	21	25	16	200
BX414MG100IR	14	12.7	22	25	16	100
BX414MG150IR	14	12.7	22	25	16	150
BX414MG200IR	14	12.7	22	25	16	200

### MODEL 3/4" square drive

We can also manufacture for your request  
ご要望により製作致します。

# Antivibration socket with ring magnet

**BIX**

## 防振ソケット リングマグネットタイプ

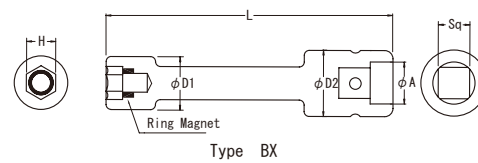
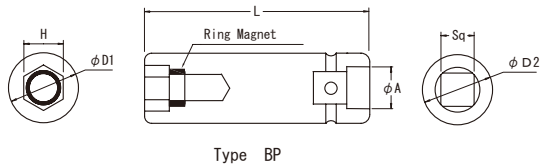

### MODEL **3/8" square drive**

EDP #	H	Sq	D1	D2	A	L
BP308RM70IR	8	9.5	14	20	12	70
BX308RM100IR	8	9.5	14	20	12	100
BP310RM70IR	10	9.5	17	20	12	70
BX310RM100IR	10	9.5	17	20	12	100
BX310RM150IR	10	9.5	17	20	12	150
BX310RM200IR	10	9.5	17	20	12	200
BP312RM70IR	12	9.5	20	20	12	70
BX312RM100IR	12	9.5	20	20	12	100
BX312RM150IR	12	9.5	20	20	12	150
BX312RM200IR	12	9.5	20	20	12	200
BP314RM70IR	14	9.5	22	20	12	70
BX314RM100IR	14	9.5	22	20	12	100
BX314RM150IR	14	9.5	22	20	12	150
BX314RM200IR	14	9.5	22	20	12	200

### MODEL **1/2" square drive**

EDP #	H	Sq	D1	D2	A	L
BP410RM75IR	10	12.7	17	25	16	75
BX410RM100IR	10	12.7	17	25	16	100
BP412RM75IR	12	12.7	20	25	16	75
BX412RM100IR	12	12.7	20	25	16	100
BX412RM150IR	12	12.7	20	25	16	150
BX412RM200IR	12	12.7	20	25	16	200
BP414RM75IR	14	12.7	22	25	16	75
BX414RM100IR	14	12.7	22	25	16	100
BX414RM150IR	14	12.7	22	25	16	150
BX414RM200IR	14	12.7	22	25	16	200

# Antivibration socket with slide magnet

## 防振ソケット スライドマグネットタイプ

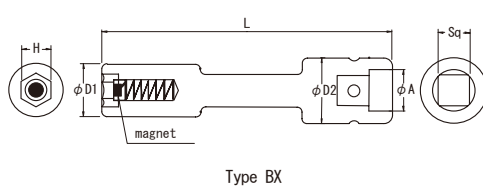
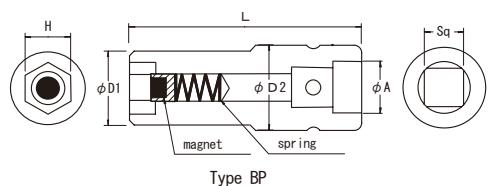

### MODEL 3/8" square drive

EDP #	H	Sq	D1	D2	A	L
BP308SM70IR	8	9.5	14	20	12	70
BP310SM70IR	10	9.5	17	20	12	70
BP310SM100IR	10	9.5	17	20	12	100
BX310SM150IR	10	9.5	17	20	12	150
BX310SM200IR	10	9.5	17	20	12	200
BP312SM70IR	12	9.5	20	20	12	70
BP312SM100IR	12	9.5	20	20	12	100
BX312SM150IR	12	9.5	20	20	12	150
BX312SM200IR	12	9.5	20	20	12	200
BP314SM70IR	14	9.5	22	20	12	70
BP314SM100IR	14	9.5	22	20	12	100
BX314SM150IR	14	9.5	22	20	12	150
BX314SM200IR	14	9.5	22	20	12	200

### MODEL 1/2" square drive

EDP #	H	Sq	D1	D2	A	L
BP412SM75IR	12	12.7	21	25	16	75
BP412SM100IR	12	12.7	21	25	16	100
BX412SM150IR	12	12.7	21	25	16	150
BX412SM200IR	12	12.7	21	25	16	200
BP413SM75IR	13	12.7	22	25	16	75
BP413SM100IR	13	12.7	22	25	16	100
BX413SM150IR	13	12.7	22	25	16	150
BX413SM200IR	13	12.7	22	25	16	200
BP414SM75IR	14	12.7	22	25	16	75
BP414SM100IR	14	12.7	22	25	16	100
BX414SM150IR	14	12.7	22	25	16	150
BX414SM200IR	14	12.7	22	25	16	200



# Antivibration universal socket



## 防振ユニバーサルソケット

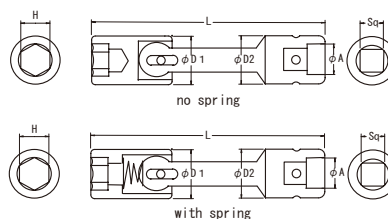

※Specify when ordering a socket with a spring.  
※スプリング入りは御指定ください

### MODEL 3/8" square drive

EDP #	H	D1	D2	A	L
BU31070IR	10	16	20	12	70
BU310100IR	10	16	20	12	100
BU310150IR	10	16	20	12	150
BU310200IR	10	16	20	12	200
BU31270IR	12	20	20	12	70
BU312100IR	12	20	20	12	100
BU312150IR	12	20	20	12	150
BU312200IR	12	20	20	12	200
BU31470IR	14	22	20	12	70
BU314100IR	14	22	20	12	100
BU314150IR	14	22	20	12	150
BU314200IR	14	22	20	12	200
BU31770IR	17	25	20	12	70

### MODEL 1/2" square drive

EDP #	H	D1	D2	A	L
BU41270IR	12	21	25	16	70
BU412100IR	12	21	25	16	100
BU412150IR	12	21	25	16	150
BU412200IR	12	21	25	16	200
BU41470IR	14	23	25	16	70
BU414100IR	14	23	25	16	100
BU414150IR	14	23	25	16	150
BU414200IR	14	23	25	16	200
BU41770IR	17	26	26	16	70
BU417100IR	17	26	26	16	100
BU417150IR	17	26	26	16	150
BU417200IR	17	26	26	16	200

# Antivibration extension bar

## 防振エクステンションバー

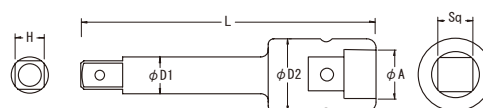

### MODEL 3/8" square drive

EDP #	H	D1	D2	A	L
BXB375IR	9.5	12	20	12	75
BXB3100IR	9.5	12	20	12	100
BXB3150IR	9.5	12	20	12	150
BXB3200IR	9.5	12	20	12	200

### MODEL 1/2" square drive

EDP #	H	D1	D2	A	L
BXB4100IR	12.7	16	25	16	100
BXB4150IR	12.7	16	25	16	150
BXB4200IR	12.7	16	25	16	200

### MODEL 3/4" square drive

EDP #	H	D1	D2	A	L
BXB6150IR	19	25	38	25	150
BXB6200IR	19	25	38	25	200